

HOLEMAKER TECHNOLOGY  
**HMT**

*Cutting Tool Innovation*

*Speed up Metalworking*

*Edition 14: 2023*

**UNPRICED**

***Portable drilling solutions to speed up  
Fabrication, Installation & Maintenance***



**VERSADRIVE**®  
PATENT PROTECTED

**VersaDrive Cutting Tools P10**

**VersaDrive Magnetic Drills P60**

**CarbideMax Broach Cutters P68**

# WHAT WE DO

**Holemaker Technology is a specialist manufacturer of cutting and drilling products**

We make the tools that allow you to create and modify the connection holes which hold our world together.

Our specialist area is Portable Cutting & Drilling tools, for those times you have to take the tools to the job.

We focus on relentless product innovation and improvement to provide the metalwork and fabrication industries with unique tooling that speeds up any task involving working with connection holes.

# OUR STORY

Initially working in a small family-run welding & engineering supplies business we received a stream of requests for specialist metal drilling tools that didn't exist no matter where we looked.

As we investigated further we discovered that drilling or modifying steel connection holes when limited to the use of portable or hand-held tools seemed to be the biggest pain point in the industry. These challenges would often contribute to missed deadlines and painful project overruns. If specifications changed at the last minute, fabrication errors were made or emergency repairs were needed, the tools needed to get the job done quickly just didn't exist in the marketplace.

The industry needed a solution so in response we formed Holemaker Technology with one aim in mind: To speed up metalworking through cutting tool innovation.

Combining our pioneering, impact rated and now patented VersaDrive system with the latest generation of high-torque cordless power tools has created a revolutionary level of drilling speed & performance, never before possible with portable tools.

9 years, around 750,000 tools and a patent or two later, these game-changing products are now sold widely in over 50 countries around the world.

There is a long way still to go and we invite you to join our journey and help us continue to improve and speed up metalworking.

Regards

Piers Crane & Hugh Crane - Co-Founders



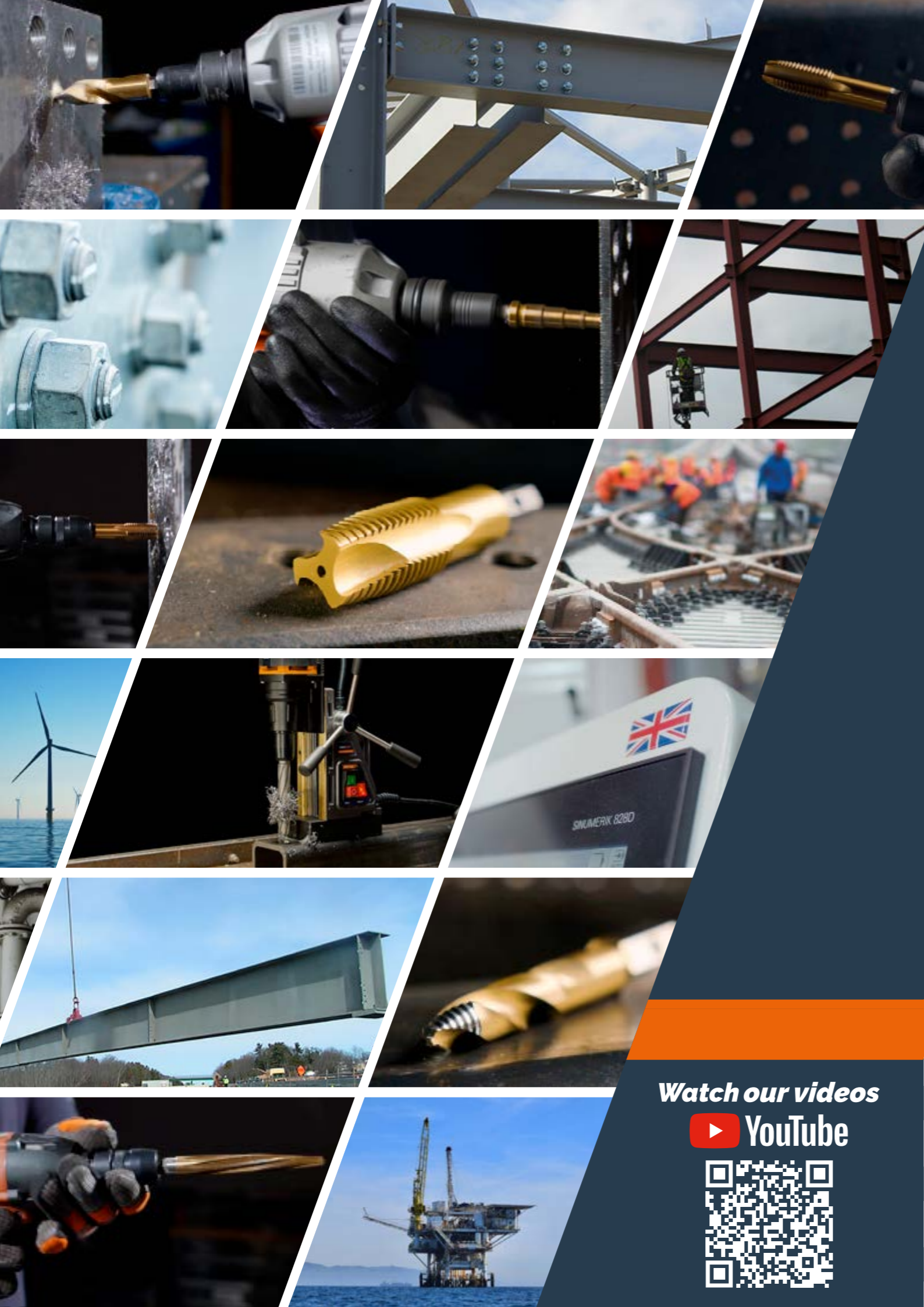

# WORKING WITH US

HOLEMAKER TECHNOLOGY  
**HMT**

We want every experience that you have with HMT to be effortless and enjoyable. Here's the 4 pillars we constantly work on and improve to deliver this.

### PRODUCTS

The motto here is - if the products are right, then the success will follow. A relentless focus on quality control and Patent-protected innovation means that each HMT product is created to be a market leader in its own right.

### SUPPORT

One of our core values is "Optimise", and this means helping users get the best out of their HMT tooling, with training, demonstrations and site visits in addition to data sheets and training videos. Over 300 dealers make the products available throughout more than 50 countries.

### SERVICE

With a stock holding of more than £2M we have over 95% stock availability on catalogue items meaning fast fulfillment of your orders. Your order will be processed & confirmed within 2 hours and courier tracking will be emailed on dispatch of goods. The HMT HUB gives the ability to order 24/7, track shipments, view stock availability, monitor back orders and much more. Meanwhile barcoded warehousing technology ensures total picking accuracy.

### TEAM

A hand picked team full of energy and enthusiasm, with industry experience drawn from market leading industrial brands.

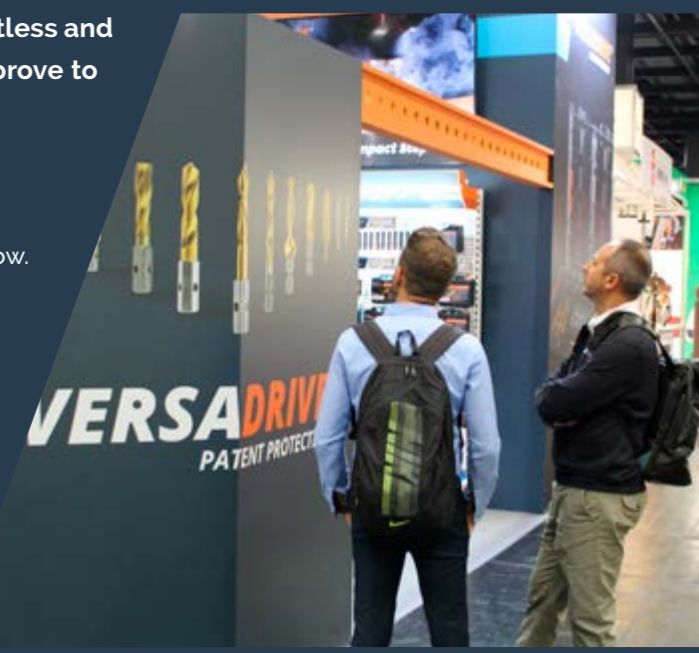

## OUR MISSION & VALUES

### HMT MISSION

*To speed up metalworking through cutting tool innovation*

### HMT VISION

*To be the leading brand of fabricators cutting tools*

### THE 5 HMT VALUES

*Innovate, Specialise, Optimise, Be Agile and Be Nice*

Watch our videos



# Bespoke Solutions

When the challenges of a job can't be met by existing tooling or machinery, contact HOLEMAKER Technology.

Our in-house technical team have over 100 years experience concepting, designing and manufacturing tooling to overcome specialist metalworking requirements and our Sheffield based CNC machinery gives us the capability to prototype and test new products that tackle the specific needs of your project.

Whatever the job, wherever it is and however you need to access it, let us know and we will work on a solution.

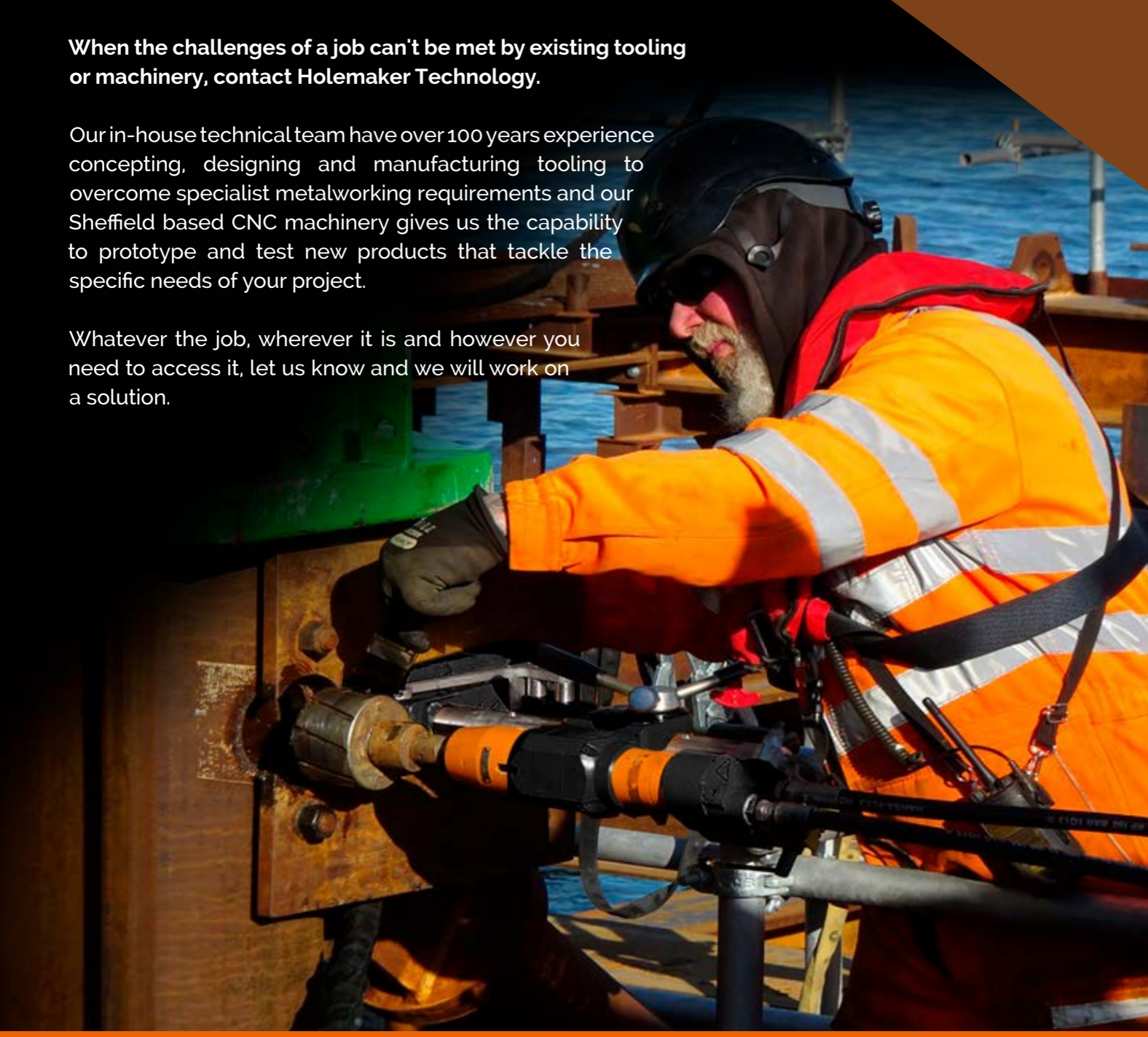

## PREVIOUS CUSTOM PROJECTS INCLUDE

The design and production of specialist pneumatic Magnet Drills for use in marine splash zones where the use of powered electromagnets was not only prohibited but dangerous.

**See image above**

Construction and modernisation of the British Antarctic Survey's Rothera Research station required specialist drilling equipment to be developed for use in the world's coldest, windiest climate whilst also contending with freezing salt water spray from the adjacent ocean.

# NEW Products

Innovation is at the heart of everything we do at HOLEMAKER Technology. Traditional methods of metalworking are often now too slow, too costly or too hazardous for modern requirements. New solutions are needed to increase efficiency, drive down costs and improve safety.

It is these solutions that we focus on creating & developing. Continual customer feedback coupled with extensive research and development allows us to identify pain points in the industry and focus on solutions that directly target the applications the industry struggles with most.

The result of this comprehensive process is a steady stream of new tooling aimed at tackling the most pressing needs of the market.



**STAKIT InsertFoam Small Sets**  
Page 50-53



**STAKIT InsertFoam Large Sets**  
Page 50-53



**Steel Erector's Snagging Kit**  
Page 57



**ULTRA Straight Flute Cutters**  
Page 85



**ULTRA Coated Twist Drills**  
Page 84



**VersaDrive MAX Reamers**  
Page 40



**Cordless Coolant Pump**  
Page 65



**V35 & V60T Pipe Magnet Drills**  
Page 62-63



**HMT MAX200T Magnet Drill**  
Page 67

Whatever your metalworking challenge, get in touch and see how we can help.

VersaDrive Adapters  
p12



VersaDrive ImpactaStep  
p16



VersaDrive Step Drills  
p18



VersaDrive TurboTips  
p20



VersaDrive Cobalt Bits  
p22



VersaDrive ImpactaTaps  
p24



UNC, BSP & BSW ImpactaTaps  
p26



Long Series ImpactaTaps  
p27



VersaDrive Farrier Taps  
p27



Clutched Adapter  
p28



Spiral Flute Taps  
p29



VersaDrive Drill Taps  
p30



Heavy Duty DrillTaps  
p32



VersaDrive DrillSink  
p34



VersaDrive Countersinks  
p36



VersaDrive Reamers  
p38



VersaDrive MAX Reamers  
p40



VersaDrive HoleCutters  
p42



STAKIT InsertFoam Sets  
p48



VersaDrive STAKIT  
p50



V35 & V35 PIPE  
p62



V60T & V60T PIPE  
p63



V85T & V100T  
p64



V125T  
p65



RTQ40 & MAX40V  
p66



MAX150T & MAX200T  
p67



CarbideMax 40 & 55  
p70



CarbideMax 80 & 110  
p72



CarbideMax 150 & 200  
p74

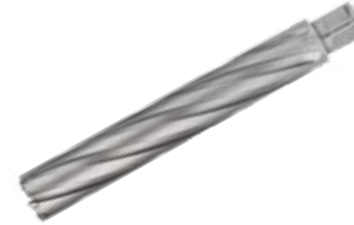

CarbideMax XL 55 & 110  
p75



CarbideMax Rail Cutters  
p76



Twist Drills  
p77



Countersinks  
p78



TCT MultiSink  
p79



ULTRA Cutters  
p80



ULTRA MultiSink  
p83



ULTRA Twist Drills  
p84



ULTRA Straight Flute Cutters  
p85



Accessories  
p86

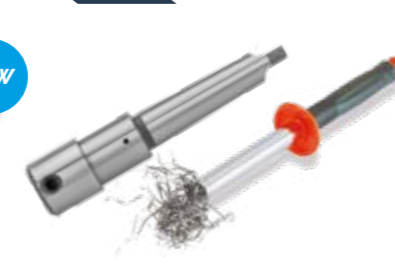

Burrs & Lubricants  
p88



# VERSADRIVE<sup>®</sup>

PATENT PROTECTED

## The world's 1st modular quick-change cutting & drilling system for use with both Impact and Rotary tools

VersaDrive by Holemaker Technology is the 1st modular cutting system in the world that allows cutting tools to be used across Impact Wrenches/Drivers as well as Rotary drills like Magnet Drills, Hand-Held drills and Pillar drills.

This innovative system features a range of Impact rated and Rotary rated cutting tools as well as a collection of specially designed and custom engineered adapters to rapidly fit cutting tool to power tool, with fast tool changeover.

Tools in the range have also been specifically designed and developed to outperform and outlast the closest comparable products. With faster cuts, longer life and more holes per product VersaDrive tools save time, money & increase productivity.



### IMPACT & ROTARY RATED

#### WHY IMPACT?

For high speed applications like drilling, reaming and tapping VersaDrive's range of Impact Rated tools and adapters offer precision performance alongside the speed, safety and controlled power offered by Impact Drivers and wrenches.

Phenomenal cutting performance is achieved through the design of the tool, cutting with the double hardened edges of the cutting face rather than the tip.

#### WHY ROTARY?

For slow speed applications like heavy duty tapping, countersinking or broaching with a holesaw optimum performance can be achieved by cutting with the tip and flutes of the tool.

Our rotary rated range of tools have been designed to do just this and provide excellent cutting performance whilst outlasting any comparable tool on the market.



Watch the video



#### The VersaDrive Patent Protected Shank System

VersaDrive Patent-Protected Hex shank. The VersaDrive Hexagon shank design fits into all standard drill chucks. No slipping in the chuck like standard tools. Three concentric lock positions give perfect alignment and accuracy when the tooling is used in any of the modular adapters to optimise metalworking processes and increase the tools working life.

#### Features & Benefits

- Up to 10x longer life
- Dual hardened for Impact use
- Safer working - minimal kickback
- Up to 15x faster than standard everyday methods
- High-Grade tool steel
- Precision ground for accurate, clean holes
- Quick-change, Rapid-Lock adapters
- Non-Slip Hex shank fits all standard 1/2" drill chucks
- GoldMax low-friction titanium coating to stop burn-out

## VersaDrive 1/4" Rapid-Lock Impact Driver Adapter

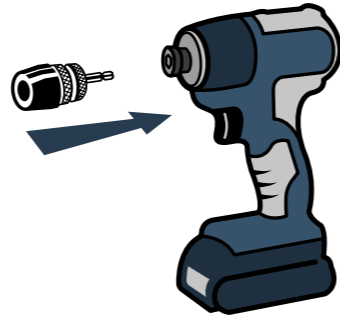

### FEATURES & BENEFITS

- Rapid-Lock, single handed loading
- Quick Release collar for swift tool changeover
- Knurled design for easy grip in damp and greasy conditions
- Collar position prevents contact with work piece and accidental tool release
- Hardened steel components with rust resistant finish
- Industrial strength to easily handle the high torque of modern Impact Drivers
- Converts standard 1/4" Impact Drivers for use with VersaDrive

Part No	Drive Size	Ø (mm)	L (mm)
111027-014A	1/4" Hex	28	75



## VersaDrive 1/2" Rapid-Lock Impact Wrench Adapter

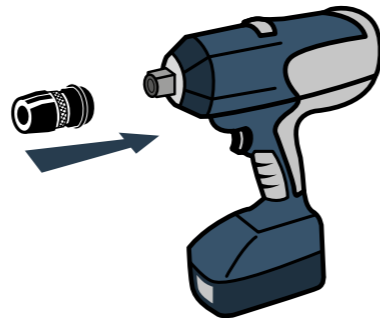
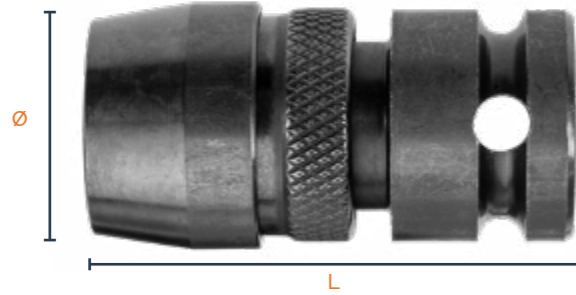

### FEATURES & BENEFITS

- Supplied with retention pin & securing ring
- Rapid-Lock, single handed loading
- Quick Release collar for swift tool changeover
- Knurled design for easy grip in damp and greasy conditions
- Collar position prevents contact with work piece and accidental tool release
- Hardened steel components with rust resistant finish
- Industrial strength to easily handle the high torque of modern Impact Wrenches
- Converts standard 1/2" Impact Wrenches for use with VersaDrive

Part No	Drive Size	Ø (mm)	L (mm)
111130-012A	1/2" Drive	28	55



## VersaDrive Heavy Duty Impact Wrench Adapter

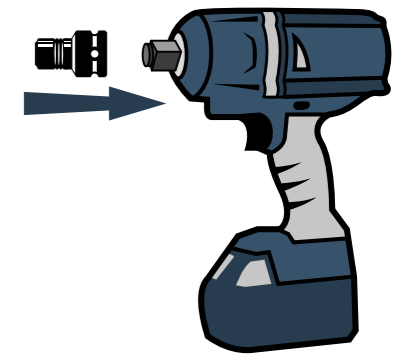

### FEATURES & BENEFITS

- Supplied with retention pin & securing ring
- Heavy duty, hardened steel components
- Quick Release collar for swift tool changeover
- Pull-forward collar design prevents accidental tool release
- Rust resistant Manganese Phosphate finish
- Industrial strength to easily handle the high torque of modern Impact Wrenches
- Converts standard 1/2" & 3/4" Impact Wrenches for use with VersaDrive

Part No	Drive Size	Ø (mm)	L (mm)
111120-012A	1/2" Drive	25	55
111120-034A	3/4" Drive	38	60



## VersaDrive Rapid-Lock Weldon Adapter

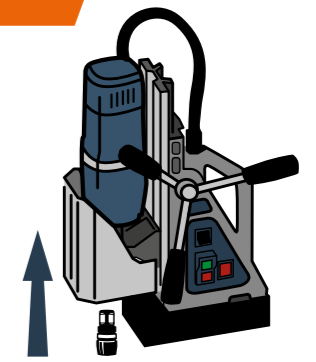

### FEATURES & BENEFITS

- Rapid-Lock, single handed loading
- Quick Release collar for swift tool changeover
- Knurled design for easy grip in damp and greasy conditions
- Collar position prevents contact with work piece and accidental tool release
- Hardened steel components with rust resistant finish
- Fits all standard Magnet Drills with 19.05mm (3/4") Weldon arbor
- Converts Magnet Drills for use with VersaDrive

Part No	Shank Size	Ø (mm)	L (mm)
111035-01	19.05mm / 3/4"	28	66



## VersaDrive Rapid-Lock SDS+ Adapter

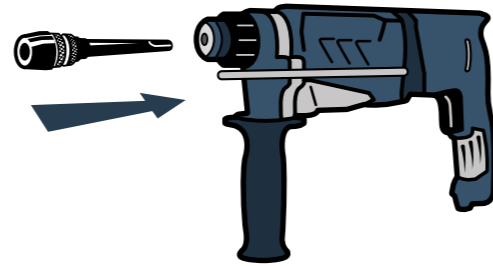
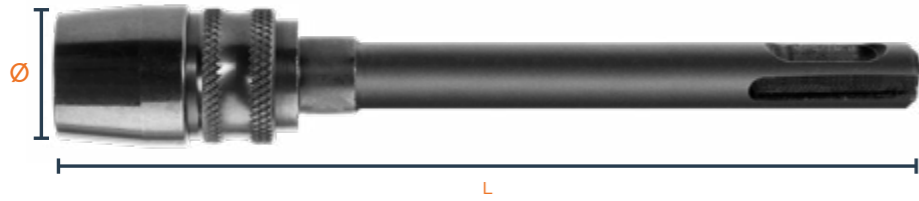

### FEATURES & BENEFITS

- Rapid-Lock, single handed loading
- Quick Release collar for swift tool changeover
- Knurled design for easy grip in damp and greasy conditions
- Collar position prevents contact with work piece and accidental tool release
- Hardened steel components with rust resistant finish
- Industrial strength to easily handle the high torque of modern Impact Drivers
- Converts standard SDS+ Rotary Hammer Drills for use with VersaDrive (Use in Rotary mode only)

Part No	Ø (mm)	L (mm)
112010-01	28	140



## VersaDrive Rapid-Lock Extension Arbor - 300mm

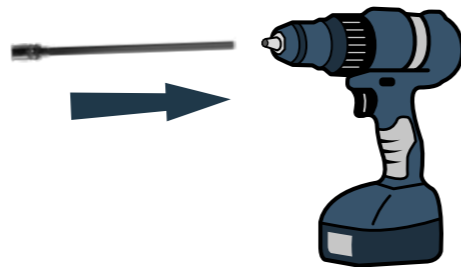

### FEATURES & BENEFITS

- Extends the working reach of all VersaDrive tools
- Can be used in conjunction with other VersaDrive adapters
- Hex shank for non-slip use in drill chucks
- Rated for Impact or Rotary use
- Rapid-Lock, single handed loading
- Quick Release collar for swift tool changeover
- Knurled design for easy grip in damp and greasy conditions
- Collar position prevents contact with work piece and accidental tool release
- Heavy duty, hardened steel components with rust resistant finish

Part No	Ø (mm)	L (mm)
111015-300	28mm	300mm



## VersaDrive Rapid-Lock Extension Arbor - 130mm

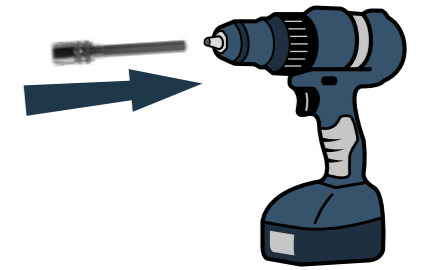

### FEATURES & BENEFITS

- Extends the working reach of all VersaDrive tools
- Can be used in conjunction with other VersaDrive adapters
- Hex shank for non-slip use in drill chucks
- Rated for Impact or Rotary use
- Rapid-Lock, single handed loading
- Quick Release collar for swift tool changeover
- Knurled design for easy grip in damp and greasy conditions
- Collar position prevents contact with work piece and accidental tool release
- Heavy duty, hardened steel components with rust resistant finish

Part No	Shank Size	Ø (mm)	L (mm)
111015-130	11mm	28	130mm



## VersaDrive Morse Taper Arbor

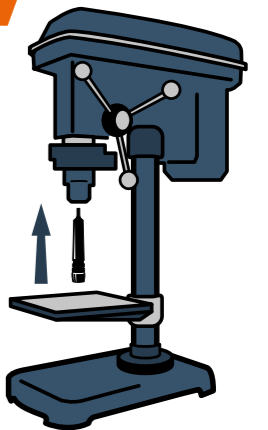

### FEATURES & BENEFITS

- Ideal for workshop use with Morse Taper Pillar Drills and Magnet Drills
- Rapid-Lock, single handed loading
- Quick Release collar for swift tool changeover
- Knurled design for easy grip in damp and greasy conditions
- Collar position prevents contact with work piece and accidental tool release
- Hardened steel components with rust resistant finish

Part No	Shank Size	Ø (mm)	L (mm)
111045-02	MT2	28	130
111045-03	MT3	28	147





A VersaDrive exclusive innovation, the ImpactaStep Cutter offers combined drilling and reaming on materials up to 12mm thick..

Featuring 5 individual cutting diameters and a straight flute design for strength and easy resharping, the ImpactaStep Cutter is optimised for use with Impact Wrenches as well as the latest range of VersaDrive Premium Magnet Drills.

VersaDrive ImpactaStep Cutters have a patented non-slip, Hex shank suitable for use in any standard 1/2" drill chuck for cordless or Pistol Drills or used with a VersaDrive Rapid Lock adapter for use in a wide range of powertools such as Magnetic Drills.



	Part No.	ØD	Ød1	l1	L	Step Diameters	Step Depth
Metric	506010-0160	16mm	8mm	79mm	107mm	8 - 10 - 12 - 14 - 16mm	12mm
	506010-0220	22mm	14mm	82mm	110mm	14 - 16 - 18 - 20 - 22mm	12mm
	506010-0260	26mm	18mm	84mm	112mm	18 - 20 - 22 - 24 - 26mm	12mm
	506010-0320	32mm	24mm	87mm	115mm	24 - 26 - 28 - 30 - 32mm	12mm
Inch	506030-0010	9/16"	5/16"	3"	4 3/16"	5/16 - 3/8 - 7/16 - 1/2 - 9/16"	15/32"
	506030-0020	13/16"	9/16"	3-1/8"	4 5/16"	9/16 - 5/8 - 11/16 - 3/4 - 13/16"	15/32"
	506030-0030	1 1/16"	13/16"	3-1/4"	4 7/16"	13/16 - 7/8 - 15/16 - 1 - 1 1/16"	15/32"



### FEATURES & BENEFITS

### QUICK GUIDE

- 5 drill bits in one
- Enlarge holes in metal up to 12mm thick
- Safety collar prevents injury & damage
- Fast, smooth drilling & reaming
- Minimal kickback
- Specially hardened for use with Impact tools
- GoldMax low-friction titanium coating stops burn out

- For fastest performance use on Impact Wrenches & Impact Drivers
- Pilot drilling is recommended for a faster operation and to enhance tool life
- When used for reaming, tool should be rotating before starting to cut with steady pressure

Find more info online



Watch the video on YouTube



"My favourite tool must be the ImpactaStep cutter. Being able to carry just a few TurboTip drill bits & the cutter means most work can be tackled."

**James Sinclair**  
**Dexta Moors**

### POWERTOOL RECOMMENDATIONS ON MILD STEEL

### DETAILED TECHNICAL ADVICE & RPM GUIDE - P.92

**Impact Drivers**  
Possible up to 16mm  
Adapter P.12

**Impact Wrenches**  
Optimal performance: Up to 32mm  
Adapter P.12

**Magnetic Drills**  
Optimal performance: Up to 32mm  
Adapter P.13

**Cordless Drills**  
Possible up to 16mm

**SDS+ Drills (Rotary only mode)**  
Possible up to 16mm  
Adapter P.14

**Pillar Drills**  
Optimal performance: Up to 32mm  
Adapter P.15

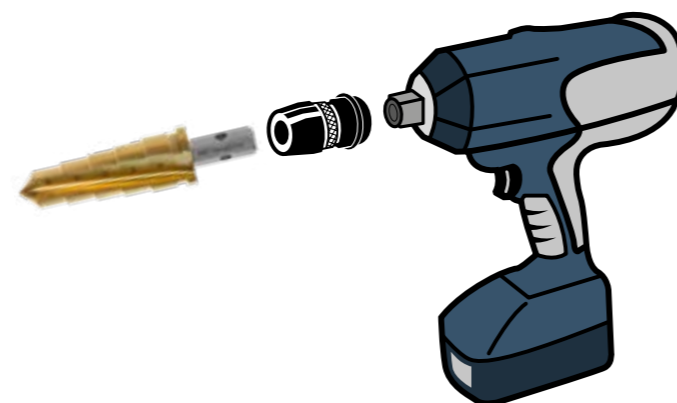

**Recommended Powertool**

**Impact Wrench**

### NEW InsertFoil Sets

Compatible with the VersaDrive **STAKIT** system

See pages 48 - 53

506010-SET1	3 pcs	16, 22, 26mm
506030-SET1	3 pcs	9/16, 13/16, 1-1/16"



\*STAKIT cases sold separately

The first step drill optimised for use with Impact Wrenches & Impact Drivers allowing the user to create holes in seconds.

Featuring a spiral flute design with self-starting drill tip, for fast, smooth drilling with a rotary drill or Impact Wrench and market leading 5mm thick drilling capacity.

VersaDrive Step Drills have a patented non-slip, Hex shank suitable for use in any standard 1/2" drill chuck for cordless or Pistol Drills or used with a VersaDrive Rapid Lock adapter for use in a wide range of powertools such as Magnetic Drills.

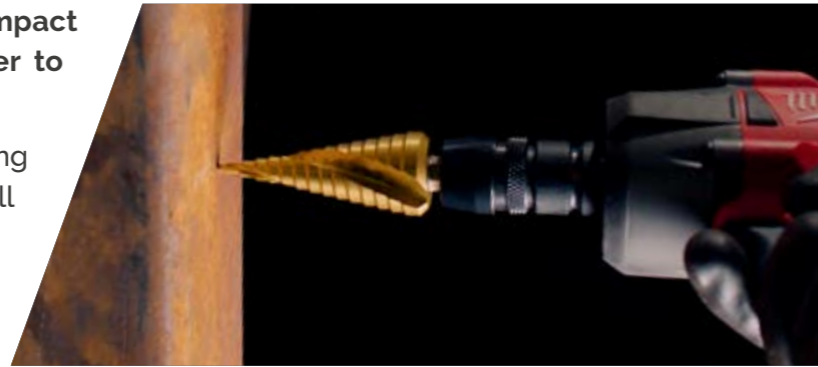

### FEATURES & BENEFITS

### QUICK GUIDE

- Market leading 5mm thick drilling capacity
- Fast, smooth drilling with minimal kickback
- Specially hardened for use with Impact tools
- Precision ground flutes with easy chip clearance
- 118° split point angle for easy starting & accuracy
- GoldMax low-friction titanium coating stops burn out

- For fastest performance use on Impact Wrenches & Impact Drivers
- Suitable for stainless and harder materials if used at low RPM
- Use appropriate lubrication and correct RPM to achieve long tool life
- Excellent life and performance when used with rotary Pistol Drills or Pillar Drills

Find more info online



Watch the video YouTube



### POWERTOOL RECOMMENDATIONS ON MILD STEEL

### DETAILED TECHNICAL ADVICE & RPM GUIDE - P.93



#### Impact Drivers

Optimal performance: Up to 30mm  
Adapter P.12

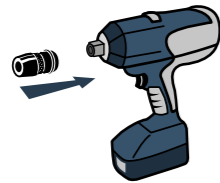

#### Impact Wrenches

Optimal performance: Up to 30mm  
Possible up to 40mm  
Adapter P.12

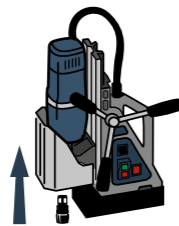

#### Magnetic Drills

Optimal performance: Up to 40mm  
Adapter P.13



#### Cordless Drills

Optimal performance: Up to 22mm  
Possible up to 40mm

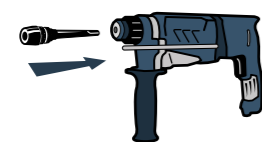

#### SDS+ Drills (Rotary only mode)

Optimal performance: Up to 30mm  
Adapter P.15

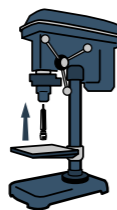

#### Pillar Drills

Optimal performance: Up to 40mm  
Adapter P.15

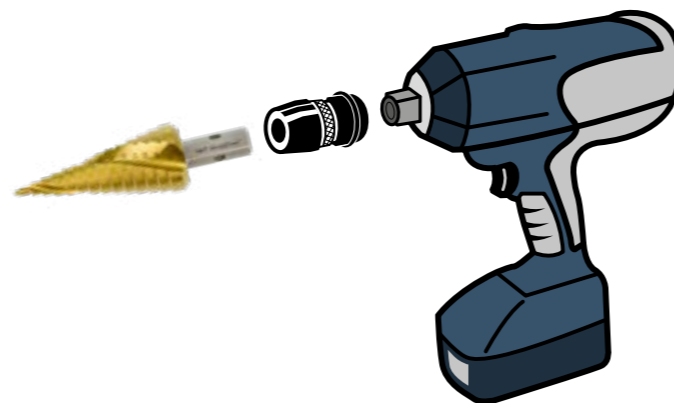

### Recommended Powertool

### Impact Wrench

	Part No.	ØD	l1	L	Step Diameters	Step Depth
Metric	505020-0120	12mm	47mm	75mm	4, 6, 8, 10, 12mm	5mm
	505020-0220	22mm	58mm	86mm	4, 6, 8, 10, 12, 14, 16, 18, 22mm	5mm
	505020-0300	30mm	77mm	105mm	4, 6, 8, 10, 12, 14, 16, 18, 20, 22, 24, 26, 28, 30mm	5mm
	505020-0400	40mm	72mm	101mm	6, 8, 10, 12, 16, 18, 20, 25, 29, 32, 36, 40mm	6mm
Electrical Step Drill 4-32.5mm						
	505040-0320	32.5mm	70mm	99mm	4, 6, 8.5, 10.5, 12.5, 14.5, 16, 18.5, 20.5, 23.5, 25, 30.5, 32.5mm	5mm

	Part No.	ØD	l1	L	Step Diameters	Step Depth
Inch	506030-0010	1/2"	1-1/2"	2-43/64"	3/16, 1/4, 5/16, 3/8, 7/16, 1/2"	3/16"
	506030-0020	7/8"	2-9/32"	3-15/32"	3/16, 1/4, 5/16, 3/8, 7/16, 1/2, 9/16, 5/8, 11/16, 3/4, 13/16, 7/8"	3/16"
	506030-0030	1-3/8"	1-31/32"	3 5/32"	1/4, 3/8, 1/2, 5/8, 3/4, 7/8, 1, 1-1/8, 1-1/4, 1-3/8"	3/16"

"We recently provided a customer the VersaDrive 22m step drill. They had been using a standard step drill and wanted to test the durability of the VersaDrive range. The customer had previously been getting approx 10 holes per drill bit. Fast forward 2 weeks - the customer advised they had already completed about 40 holes and the VersaDrive Step Drill showed no sign of losing any of its performance!"

BBF Industrial

### NEW InsertFoil Sets

Compatible with the VersaDrive STAKIT system

See pages 48 - 53

505020-SET1	3 pcs	12, 22, 30mm
505020-SET2	4 pcs	12, 22, 30, 40mm
505030-SET1	3 pcs	1/2, 7/8, 1-3/8"



\*STAKIT cases sold separately

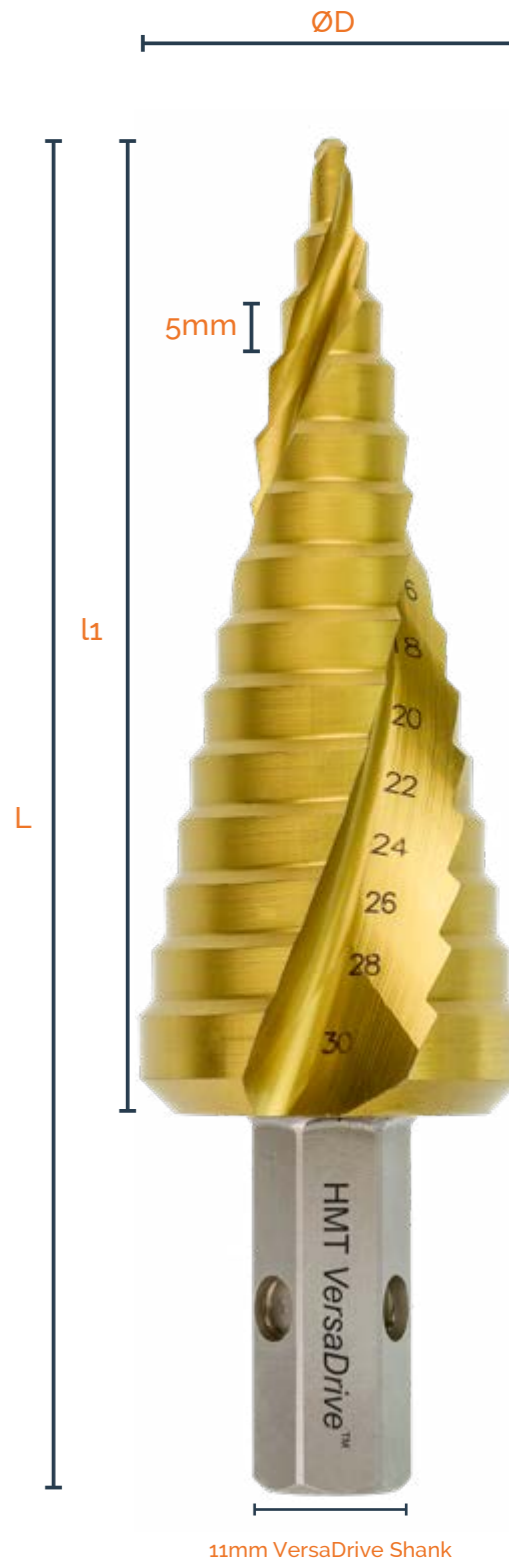

VersaDrive TurboTip Impact drill bits are stepped tip bits that drill at twice the speed of standard bits without the need for pilot drilling while cutting a perfectly round hole.

Turbocharge your drilling performance by using this revolutionary tool with an Impact Wrench or Impact Driver. Double hardened and titanium coated for faster drilling & reduced wear.

VersaDrive TurboTip drill bits have a patented non-slip, Hex shank suitable for use in any standard 1/2" drill chuck for cordless or Pistol Drills or used with a VersaDrive Rapid Lock adapter for use in a wide range of powertools such as Magnetic Drills.



### FEATURES & BENEFITS

- No pilot drilling needed
- Patented Drill Point
- 50% Faster Drilling with 30% less pressure
- Incredible Finished Hole quality
- Instant drill start with no slipping
- No 'snatch' when drill bit breaks through
- Fully Impact Rated on structural steel

### QUICK GUIDE

- For fastest performance use on Impact Wrenches & Impact Drivers
- For optimum life and accuracy use with Pistol Drills and Magnet Drills
- Suitable for use on Stainless Steel and harder materials if used at low RPM in rotary tools
- Use appropriate lubrication & correct RPM to achieve long tool life

Find more info online



Watch the video on YouTube



### POWERTOOL RECOMMENDATIONS ON MILD STEEL

### DETAILED TECHNICAL ADVICE & RPM GUIDE - P.94



**Impact Drivers**

Optimal performance: Up to 10mm  
Adapter P.12

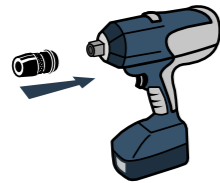

**Impact Wrenches**

Optimal performance: Up to 14mm  
Possible use up to 22mm  
Adapter P.12

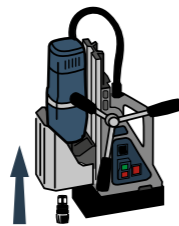

**Magnetic Drills**

Optimal performance: Up to 16mm  
Possible use up to 22mm  
Adapter P.13



**Cordless Drills**

Optimal performance: Up to 12mm

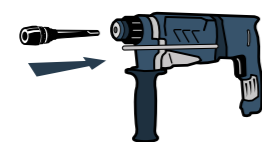

**SDS+ Drills (Rotary only mode)**

Optimal performance: Up to 14mm  
Adapter P.14

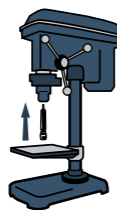

**Pillar Drills**

Optimal performance: Up to 22mm  
Adapter P.15

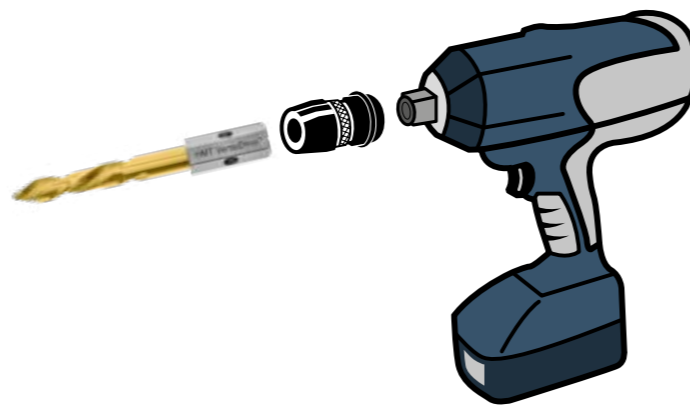

**Recommended Powertool**

**Impact Wrench**

	Part No.	ØD	Tap Size
Metric	209015-0060	6mm	
	209015-0068	6.8mm	M8
	209015-0070	7mm	
	209015-0080	8mm	
	209015-0085	8.5mm	M10
	209015-0090	9mm	
	209015-0100	10mm	
	209015-0105	10.5mm	M12
	209015-0110	11mm	
	209015-0120	12mm	M14
	209015-0130	13mm	
	209015-0140	14mm	M16
	209015-0160	16mm	
209015-0180	18mm		
209015-0200	20mm		
209015-0220	22mm		

	Part No.	ØD	Tap Size
Inch	209016-0010	3/16"	4.8mm
	209016-0020	#7	5.1mm
	209016-0030	7/32"	5.6mm
	209016-0040	1/4"	6.4mm
	209016-0050	#F	6.6mm
	209016-0060	9/32"	7.1mm
	209016-0070	5/16"	7.9mm
	209016-0080	11/32"	8.7mm
	209016-0090	3/8"	9.5mm
	209016-0100	27/64"	10.7mm
	209016-0120	7/16"	11.1mm
	209016-0130	1/2"	12.7mm

### NEW InsertFoil Sets

Compatible with the VersaDrive STAKIT system

See pages 48 - 53

209015-SET1	4 pcs	6, 8, 10, 12mm
209015-SET2	7 pcs	6, 7, 8, 9, 10, 11, 12mm
209015-SET3	7 pcs	6.8, 8, 8.5, 10, 10.5, 12, 14mm
209015-SET4	7 pcs	6, 8, 10, 12, 14, 18 & 22mm
209016-SET1	4 pcs	3/16, 1/4, 5/16, 1/2"
209016-SET2	4 pcs	#7, F, 5/16, 27/64



\*STAKIT cases sold separately

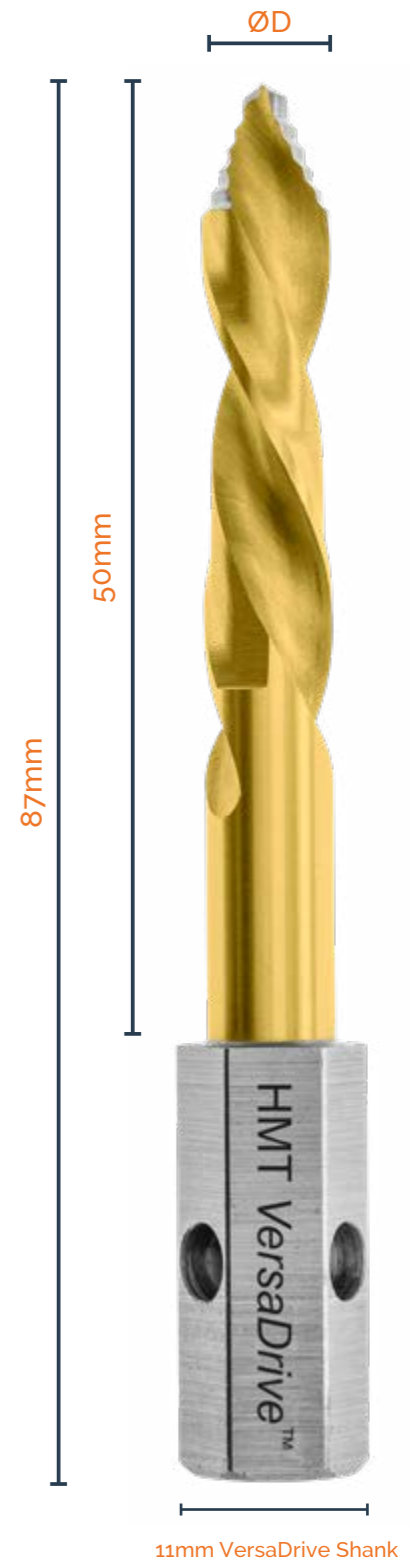

VersaDrive Cobalt Drills are a premium grade 8% Cobalt drill bit with fully ground flutes, 135° Split point and Titanium coating for faster drilling & reduced wear.

Suitable for heavy fabrication use, this Cobalt drill bit can also be used to drill stainless steel, mild steel, cast iron and a wide range of other structural materials.

VersaDrive Drill Bits have a patented non-slip, Hex shank suitable for use in any standard 1/2" drill chuck for cordless or Pistol Drills or used with a VersaDrive Rapid Lock adapter for use in a wide range of power tools such as Magnetic Drills.



Part No.	Ø D (mm)	Tap Size (Metric Coarse)	Length in Magnet Drill Adapter (mm)
209010-0042	4.2	M5	98
209010-0050	5	M6	98
209010-0055	5.5	-	98
209010-0060	6	-	98
209010-0065	6.5	-	98
209010-0068	6.8	M8	98
209010-0070	7	-	98
209010-0075	7.5	-	98
209010-0080	8	-	98
209010-0085	8.5	M10	98
209010-0090	9	-	98
209010-0095	9.5	-	98
209010-0100	10	-	98
209010-0102	10.2	M12	98
209010-0105	10.5	-	98
209010-0115	11.5	-	98
209010-0120	12	M14	98
209010-0125	12.5	-	98
209010-0130	13	-	98
209010-0140	14	M16	98
209010-0155	15.5	M18	98
209010-0160	16	-	98
209010-0175	17.5	M20	98
209010-0180	18	-	98
209010-0200	20	-	98
209010-0210	21	M24	98
209010-0220	22	-	98



## FEATURES & BENEFITS

## QUICK GUIDE

- Fast drilling with minimal kickback
- Dual hardened for Impact use up to 10mm
- Precision ground flutes
- Easy chip clearance
- 8% Cobalt for long life & endurance
- 135° split point for easy starting & high accuracy
- GoldMax low-friction titanium coating to stop burn out

- Optimum life and performance when used with rotary Pistol Drills
- Up to 10.5mm can be used with impact tools for fast cutting performance
- Suitable for use on Stainless Steel and harder materials if used at low RPM in rotary tools
- Use appropriate lubrication & correct RPM to achieve long tool life

Find more info online



Watch the video on YouTube



## POWERTOOL RECOMMENDATIONS ON MILD STEEL

## DETAILED TECHNICAL ADVICE & RPM GUIDE - P.95



**Impact Drivers**

Possible use up to 10.5mm

Adapter P.12

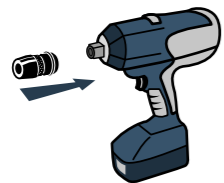

**Impact Wrenches**

Possible use up to 10.5mm

Adapter P.12

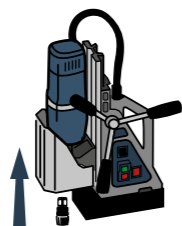

**Magnetic Drills**

Optimal performance: Up to 16mm  
Possible use up to 22mm  
Adapter P.13

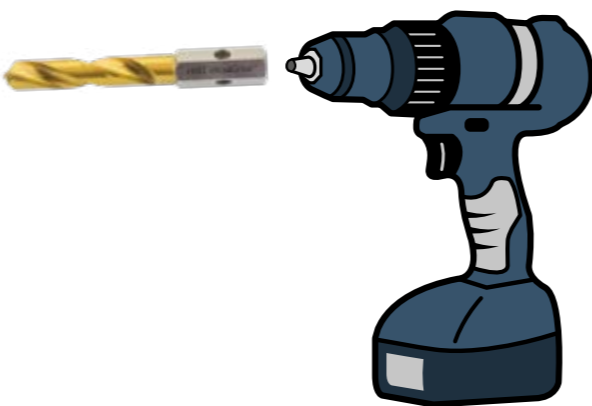

## Recommended Powertool

## Cordless Drill



**Cordless Drills**

Optimal performance: Up to 14mm  
Possible use up to 22mm

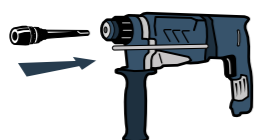

**SDS+ Drills (Rotary only mode)**

Possible use up to 14mm

Adapter P.14

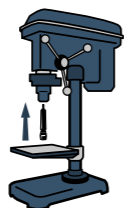

**Pillar Drills**

Optimal performance: Up to 22mm  
Adapter P.15

## NEW InsertFoil Sets

Compatible with the VersaDrive STAKIT system

See pages 48 - 53

209010-SET1	4 pcs	6, 8, 10, 12mm
209010-SET2	4 pcs	5, 6.8, 8.5, 10.2mm
209010-SET3	7 pcs	5, 6, 6.8, 8, 8.5, 10, 10.2mm
209010-SET4	7 pcs	12, 13, 14, 16, 18, 20, 22mm



\*STAKIT cases sold separately

VersaDrive ImpactaTaps are the first and only range of taps that are suitable to be driven by Impact Wrenches and Impact Drivers, providing at least 15x faster performance than tapping by hand.

With a specially designed twin-lead, cutting geometry - the dual hardening process with Titanium coating provides a fantastic solution for tapping holes in steel.

VersaDrive ImpactaTaps have a patented non-slip, Hex shank suitable for use in any standard 1/2" drill chuck for cordless or Pistol Drills (up to M10) or used with a VersaDrive Rapid Lock adapter for use in a wide range of power tools such as Magnetic Drills. They can even be used by hand in a socket wrench.

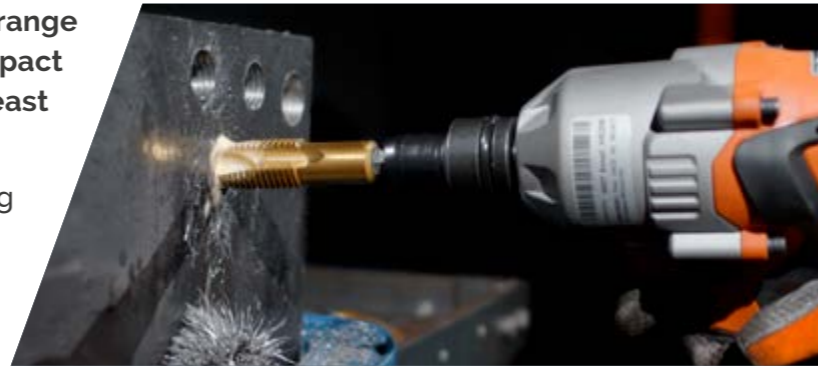

### FEATURES & BENEFITS

### QUICK GUIDE

- Ground flutes create the perfect tapped hole
- Safer tapping with minimal kickback
- Specially hardened for use with Impact tools
- High grade tool steel for long life
- High accuracy
- Wide range of sizes
- GoldMax low-friction titanium coating to stop burn out

- For fastest performance use on Impact Wrenches & Impact Drivers
- Check minimum torque requirement on P.96
- Tapping Stainless Steel requires higher impact torque
- Use appropriate lubrication and correct RPM to achieve long tool life

Find more info online



Watch the video YouTube



### POWERTOOL RECOMMENDATIONS ON MILD STEEL

### DETAILED TECHNICAL ADVICE & RPM GUIDE - P.96

**Impact Drivers**  
Optimal performance: Up to M12  
Possible use up to M16mm Adapter P.12

**Impact Wrenches**  
Optimal performance: Up to M30mm  
Adapter P.12

**Reversible Magnetic Drills**  
Optimal performance: Up to M30  
Adapter P.13

**Cordless Drills**  
Optimal performance: Up to M8  
Possible use up to M12

**Pillar Drills**  
Optimal performance: Up to M30  
Adapter P.15

**SDS+ Drills**  
Not Recommended

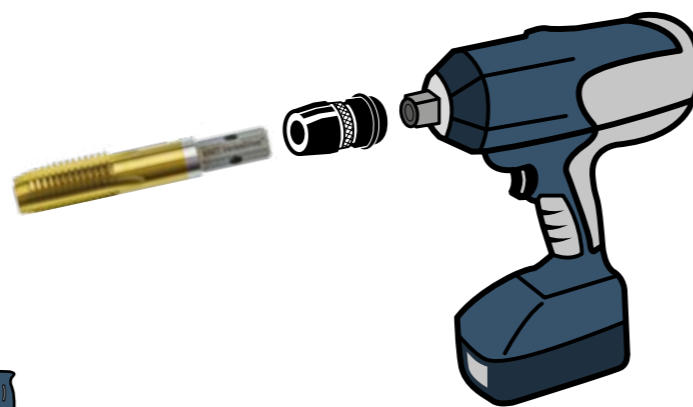

**Recommended Power tool**  
**Impact Wrench**

	Part No.	M Thread Size & Pitch	L (mm)	l1 (mm)	Tap Hole Size (Metric Coarse mm)
<b>Metric Coarse</b>	308010-0050	M5 x 0.80	55	18	4.2
	308010-0060	M6 x 1.00	55	20	5
	308010-0080	M8 x 1.25	60	22	6.8
	308010-0100	M10 x 1.50	70	24	8.5
	308010-0120	M12 x 1.75	80	29	10.2
	308010-0140	M14 x 2.00	90	32	12
	308010-0160	M16 x 2.00	90	32	14
	308010-0180	M18 x 2.50	100	37	15.5
	308010-0200	M20 x 2.50	100	37	17.5
	308010-0240	M24 x 3.00	110	45	21
308010-0270	M27 x 3.00	130	48	24	
308010-0300	M30 x 3.50	130	48	26.5	

"M16 tap performed perfect today on stainless steel. Couldn't have gotten in there with any other tool. It saved a million pound vessel from being fully re-worked. The customer was amazed how I managed to tap that hole in such an awkward place so quickly, saved a lot of down time for the vessel."

**JM Weld Instagram**

### NEW InsertFoil Sets

Compatible with the VersaDrive STAKIT system

See pages 48 - 53

308010-SET1	5 pcs	M6, M8, M10, M12, M16
308010-SET2	4 pcs	M12, M16, M20, M24

### ImpactaTap & TurboTip Combination Set

328015-SET1	8 pcs	6.8, 8.5, 10.5 & 14mm TurboTips M8, M10, M12, M16 ImpactaTaps
-------------	-------	--



\*STAKIT cases sold separately

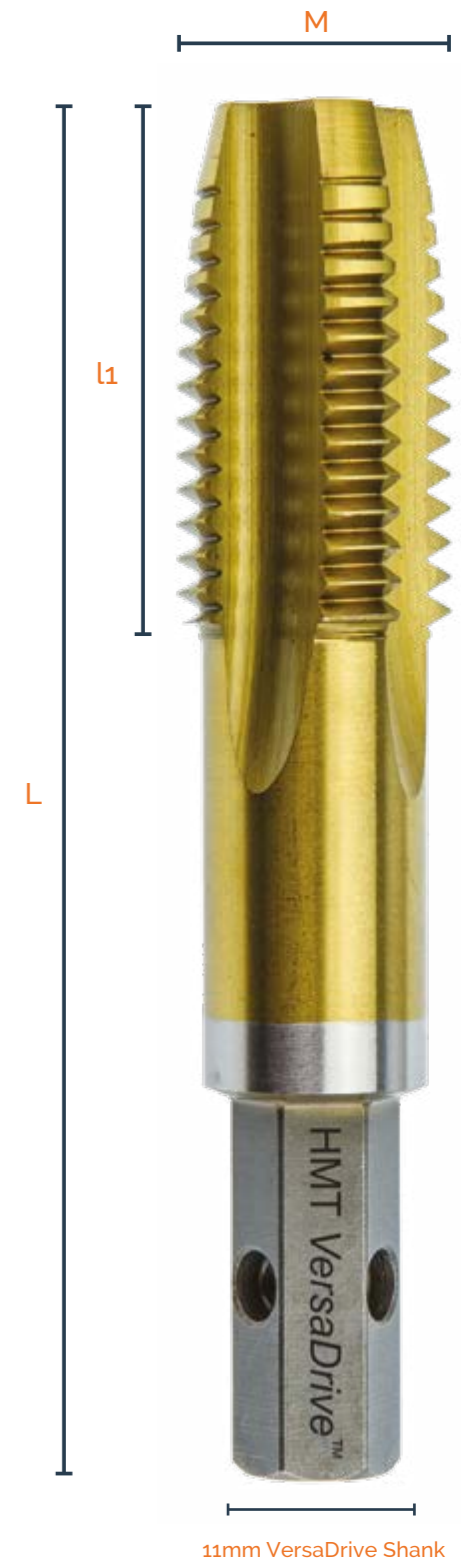

## ImpactaTaps® UNC Thread

Part No	M Thread Size & Pitch	L (mm)	I1 (mm)	Tap Hole Size (mm)	Tap Hole Size (Inch)
308050-0010	1/4 x 20 UNC	58	20	5.1	#7
308050-0020	5/16 x 18 UNC	60	22	6.6	#F
308050-0030	3/8 x 16 UNC	70	24	8	5/16
308050-0040	1/2 x 13 UNC	80	29	10.8	27/64
308050-0050	5/8 x 11 UNC	90	32	13.5	17/32
308050-0060	3/4 x 10 UNC	100	37	16.5	21/32
308050-0065	7/8 x 9 UNC	105	40	19.5	49/64
308050-0070	1 x 8 UNC	110	45	22.25	7/8
Sets		Contents			
308050-SET1	HMT VersaDrive ImpactaTap Set, 1/4, 5/16, 3/8, 1/2, 5/8 UNC				
308050-SET2	HMT VersaDrive ImpactaTap Set, 1/2, 5/8, 3/4, 1"				

## ImpactaTaps® Metric Fine Thread

Part No	M Thread Size & Pitch	L (mm)	I1 (mm)	Tap Hole Size (mm)
308030-0060	M6 x 0.75 MF	60	19	5.2
308030-0800	M8 x 1.00 MF	70	22	7.0
308030-0100	M10 x 1.25 MF	70	24	8.8
308030-0120	M12 x 1.50 MF	80	29	10.5
308030-0160	M16 x 1.50 MF	90	32	14.5
308030-0180	M18 x 1.50 MF	100	37	16.5
308030-0200	M20 x 1.50 MF	100	37	18.5
308030-0240	M24 x 1.50 MF	120	92	22.5

## ImpactaTaps® BSP Thread

Part No	M Thread Size & Pitch	L (mm)	I1 (mm)	Tap Hole Size (mm)
308070-0010	1/8 x 28 BSP	70	24	8.8
308070-0020	1/4 x 19 BSP	90	32	11.8
308070-0030	3/8 x 19 BSP	90	32	15.25
308070-0040	1/2 x 14 BSP	100	37	19
308070-0050	5/8 x 14 BSP	100	37	21
308070-0060	3/4 x 14 BSP	100	37	24.5
308070-0070	1 x 11 BSP	110	45	30.75

## ImpactaTaps® BSW Thread

Part No	M Thread Size & Pitch	L (mm)	I1 (mm)	Tap Hole Size (mm)
308060-0010	1/4 x 20 BSW	58	20	5.1
308060-0015	5/16 x 18 BSW	60	22	6.5
308060-0020	3/8 x 16 BSW	70	24	7.9
308060-0030	1/2 x 12 BSW	80	29	10.5
308060-0040	5/8 x 11 BSW	90	32	13.5
308060-0050	3/4 x 10 BSW	100	37	16.25
308060-0060	1 x 8 BSW	110	45	22

## ImpactaTaps® Long Series - Metric Coarse

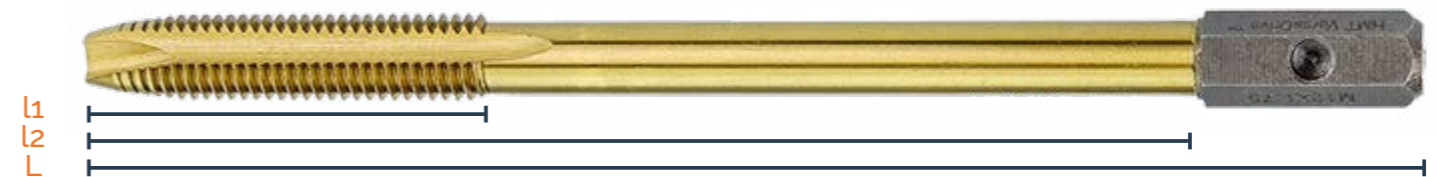

Part No	M Thread Size & Pitch	L (mm)	I1 (mm)	I2 (mm)	Tap Hole Size (mm)
308015-0080	M8 x 1.25	140	45	112	6.8
308015-0100	M10 x 1.50	155	50	127	8.5
308015-0120	M12 x 1.75	180	55	152	10.2
308015-0160	M16 x 2.0	200	65	172	14
308015-0200	M20 x 2.5	230	70	202	17.5
308015-0240	M24 x 3.0	260	75	232	21

Spiral Point Taps for fast chip ejection in through holes.

## Metric Coarse Oversized ImpactaTaps®

For use with Galvanised Fixings

Part No	M Thread Size & Pitch	L (mm)	I1 (mm)	Tap Hole Size (Metric Coarse thread)	
308020-0050	M5.4 x 0.80mm	55	18	4.2	
308020-0060	M6.4 x 1.00mm	55	20	5.0	
308020-0080	M8.4 x 1.25mm	60	22	6.8	
308020-0100	M10.4 x 1.50mm	70	24	8.5	
308020-0120	M12.4 x 1.75mm	80	29	10.2	
308020-0160	M16.4 x 2.00mm	90	32	14.0	
308020-0200	M20.4 x 2.50mm	100	37	17.5	
308020-0240	M24.4 x 3.00mm	110	45	21.0	
308020-0300	M30.4 x 3.50mm	130	48	26.5	
Sets		Contents			
308020-SET1	VersaDrive Oversize Galv ImpactaTap 6 Pc Set: M5, M6, M8, M10, M12, M16				

## FarrierTap - BSW Thread

### FarrierTap - BSW Thread

Part No	M Thread Size & Pitch	L (mm)	I1 (mm)	Tap Hole Size (mm)
308060-0015	5/16 x 18 BSW	60	22	6.5
308060-0020	3/8 x 16 BSW	70	24	7.9

### FarrierTap Combi DrillTap

Part No	M Thread Size & Pitch	d1 (mm)	L (mm)	I1 (mm)	Max tapping depth with Impact Wrench (mm)
301127-0030	3/8-16 BSW	7.9	92	22	8.5

### FarrierTap Kit

Part No:	Set Contents
301127-SET1	Set contains: 3/8 BSW FarrierTap, 3/8 BSW Combi Drill Tap, 1/4" VersaDrive Impact Adapter



## Clutched Tap Collet for Blind Hole Tapping

## IMPACT RATED

## VersaDrive Spiral Flute Taps

## IMPACT RATED

The HMT VersaDrive Clutched tap collet system is a unique method of effectively threading blind holes.

The collet works with the range of Patented VersaDrive taps. When the tap comes to the bottom of the hole, the clutch system will engage and stop the tap from breaking. The tap is then reversed out of the completed hole.

This system fits a 19.05mm (3/4") Magnet Drill arbor, or can be adapted for use with a 1/2" or 3/4" Impact Wrench.



*N.B. Assembled length of Clutched adapter with fitted tap is up to 250mm - ensure you select a mag drill with adequate stroke e.g. V100T & V125T VersaDrive Magnet Drills*

### FEATURES & BENEFITS

- Quick change system accepts all VersaDrive taps
- Collets are pre-set to the appropriate clutch settings
- Further clutch adjustment options available
- For blind hole tapping with VersaDrive Spiral Flute Taps
- For use with variable speed, reversible, Magnet Drills, pillar drills and Impact Wrenches

Find more info online



Watch the video YouTube



Part No	Description
120010	Weldon Shank Tap Collet Holder, 19.05mm / 3/4



121015-M12	Clutched Blind Hole Tap Collet M8-M12 Capacity
121015-M24	Clutched Blind Hole Tap Collet M16-M24 Capacity



00200-12A-19	1/2" Drive Impact Adapter for Blind Hole Tapping
00200-34A-19	3/4" Drive Impact Adapter for Blind Hole Tapping
121015-SET12	Blind Hole Tapping Kit M8-M24 Includes 1/2" Impact Adapter
121015-SET34	Blind Hole Tapping Kit M8-M24 Includes 3/4" Impact Adapter



	Part No	M Thread Size & Pitch	L	l1	Tap Hole Size (mm)	Tap Hole Size (")
Metric Coarse	309010-0060	M6 x 1.00	58mm	20mm	5.0	-
	309010-0080	M8 x 1.25	60mm	22mm	6.8	-
	309010-0100	M10 x 1.50	70mm	24mm	8.5	-
	309010-0120	M12 x 1.75	80mm	29mm	10.2	-
	309010-0160	M16 x 2.00	90mm	32mm	14.0	-
	309010-0200	M20 x 2.50	100mm	37mm	17.5	-
	309010-0240	M24 x 3.00	110mm	45mm	21.0	-
	309010-0300	M30 x 3.50	130mm	48mm	26.5	-

Inch	309020-0010	1/4 x 20 UNC	2-3/8"	63/64"	5.1	#7
	309020-0020	5/16 x 18 UNC	2-3/8"	63/64"	6.6	#F
	309020-0030	3/8 x 16 UNC	2-3/4"	1"	8	5/16
	309020-0040	1/2 x 13 UNC	3-1/8"	1-3/64"	10.8	27/64
	309020-0050	5/8 x 11 UNC	3-1/2"	1-5/64"	13.5	17/32
	309020-0060	3/4 x 10 UNC	3-31/32"	1-9/64"	16.5	21/32
	309020-0065	7/8 x 9 UNC	4-1/8"	1-13/16"	19.5	49/64
	309020-0070	1 x 8 UNC	4-3/8"	2"	22.25	7/8
	309020-0110	1-1/4 x 7 UNC	5"	2"	28	1-7/64

### NEW InsertFoam Sets

Compatible with the VersaDrive STAKIT system

See pages 48 - 53

309010-SET1	5 pcs	M6, M8, M10, M12, M16
309010-SET2	4 pcs	M12, M16, M20, M24
309020-SET1	5 pcs	1/4, 5/16, 3/8, 1/2, 5/8" UNC
309020-SET2	3 pcs	1/2, 3/4, 1" UNC

### POWERTOOL RECOMMENDATIONS ON MILD STEEL

DETAILED ADVICE & RPM GUIDE - P.96

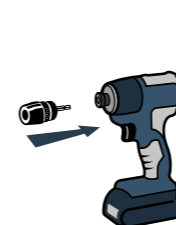

#### Impact Drivers

Possible use up to M10 for through holes

Adapter P.12

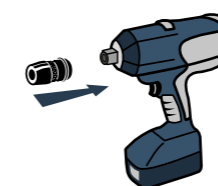

#### Impact Wrenches

Possible use up to M30 with clutched adapter

Adapter P.12

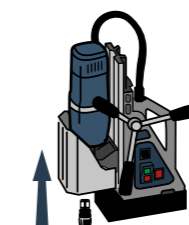

#### Reversible Magnetic Drills

Optimal performance: Up to M30 with clutched adapter Adapter P.13



#### Cordless Drills

Possible use up to M10 for through holes

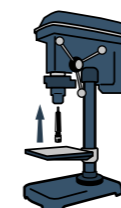

#### Pillar Drills

Optimal performance: Up to M30 with clutched adapter Adapter P.15



11mm VersaDrive Shank

### Recommended Powertool

### Magnet Drill with Clutched Adapter

VersaDrive Drill Taps are a time saving solution for pilot drilling & tapping in one easy operation. The Titanium coating provides wear resistance and faster cutting performance.

VersaDrive Sheet Metal Impacta-DrillTaps have a patented non-slip, Hex shank suitable for use in any standard 1/2" drill chuck for cordless or Pistol Drills or used with a VersaDrive Rapid Lock adapter for use in a wide range of powertools such as Magnetic Drills.

Recommended for use with Impact Drivers for high drilling and tapping productivity.



	Part No	M Thread Size & Pitch	Max Material Thickness	Ød1	L	l1
Metric	301125-0030	M3 x 0.50	3mm	2.5mm	55mm	6mm
	301125-0040	M4 x 0.70	4mm	3.3mm	60mm	9mm
	301125-0050	M5 x 0.80	5mm	4.2mm	71mm	13mm
	301125-0060	M6 x 1.00	6mm	5.0mm	75mm	17mm
	301125-0080	M8 x 1.25	8mm	6.8mm	82mm	20mm
	301125-0100	M10 x 1.50	10mm	8.5mm	92mm	25mm
	301125-0120	M12 x 1.75	12mm	10.2mm	103mm	31mm

Inch	301126-0010	4-40 UNC	3/32"	3/32"	2-11/64"	15/64"
	301126-0020	6-32 UNC	1/8"	7/64"	2-23/64"	23/64"
	301126-0030	8-32 UNC	5/32"	9/64"	2-23/64"	23/64"
	301126-0040	10-24 UNC	13/64"	5/32"	2-51/64"	33/64"
	301126-0050	1/4-20 UNC	1/4"	13/64"	2-61/64"	19/32"
	301126-0060	5/16-18 UNC	5/16"	1/4"	3-15/64"	45/64"
	301126-0070	3/8-16 UNC	3/8"	5/16"	3-5/8"	55/64"
	301126-0080	1/2-13 UNC	1/2"	27/64"	4/16"	1-7/64"

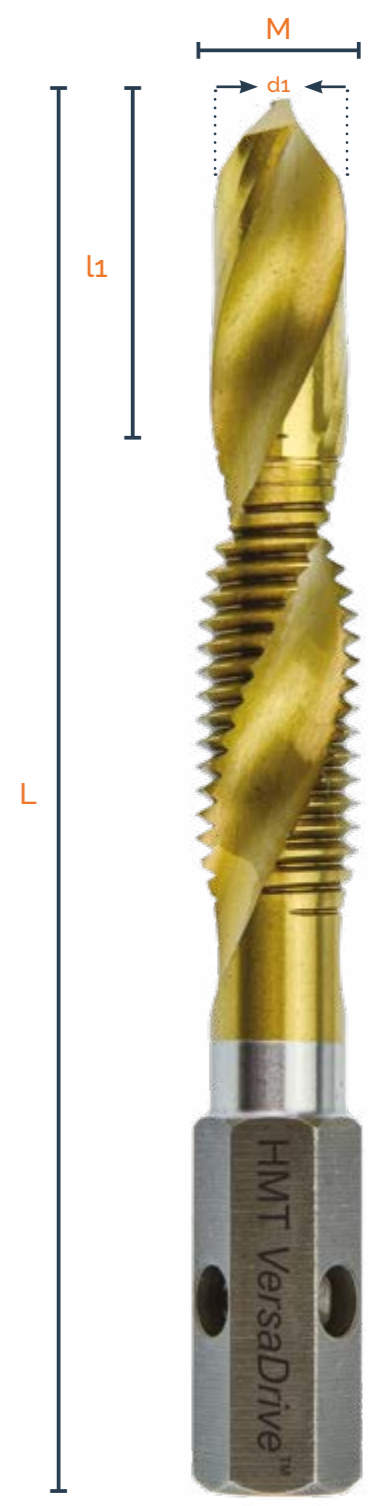

11mm VersaDrive Shank

### FEATURES & BENEFITS

### QUICK GUIDE

- Drill & Tap in one easy operation
- Ground flute twist drill
- Creates perfect tapping hole
- Safer tapping with minimal kickback
- Specially hardened for use with Impact tools
- High grade tool steel for high accuracy & long life
- GoldMax low friction Titanium coating to stop burn out

- For fastest performance use on Impact Wrenches & Impact Drivers
- Tapping Stainless Steel requires higher Impact torque
- For maximum tapping depth at each DrillTap size - see table opposite
- Use appropriate lubrication & correct RPM to achieve long tool life

Find more info online



Watch the video YouTube



*"This impact drilltap combo is amazing! No risk of snagging wrists etc and jamming up of the drill when used in the impact gun. Keep it lubed up and the performance is great."*

**Tim Berry**  
AnyWeld

### POWERTOOL RECOMMENDATIONS ON MILD STEEL

### DETAILED TECHNICAL ADVICE & RPM GUIDE - P.97

**Impact Drivers**  
Optimal performance: Up to M8  
Possible use up to M12  
Adapter P.12

**Impact Wrenches**  
Optimal performance: M10 & M12  
Possible use M3 - M8  
Adapter P.12

**Reversible Magnetic Drills**  
Optimal performance: Up to M12  
Adapter P.13

**Cordless Drills**  
Optimal performance: Up to M6  
Possible use up to M12

**Pillar Drills**  
Optimal performance: Up to M12  
Adapter P.15

**SDS+ Drills**  
Not Recommended

**Recommended Powertool**  
**Impact Driver**

### NEW InsertFoil Sets

Compatible with the VersaDrive **STAKIT** system

See pages 48 - 53

301125-SET1	5 pcs	M5, M6, M8, M10, M12
301126-SET1	4 pcs	1/4, 5/16, 3/8, 1/2" UNC



\*STAKIT cases sold separately



VersaDrive Heavy Duty Drill Taps are an industrial metalwork or fabrication tool for drilling and tapping heavy steel in one easy operation.

Primarily they are designed to be used with a reversible Magnet Drill, although they can also be adapted for use with an Impact Wrench to enlarge and tap existing holes.

With a drill point optimised for use in fixed drilling machines like Magnetic Drills or Pillar drills, these are not recommended for use in a Pistol Drill. Where they are to be used with an Impact Wrench to enlarge and tap holes pilot drilling is recommended with a separate drill bit.



	Part No	M Thread Size & Pitch	Ød1	L	l1	Max Tapping Depth
<b>Metric</b>	301130-0080	M8 x 1.25	6.8mm	100mm	30mm	20mm
	301130-0100	M10 x 1.50	8.5mm	105mm	30mm	20mm
	301130-0120	M12 x 1.75	10.2mm	117mm	35mm	25mm
	301130-0160	M16 x 2.00	14mm	117mm	37mm	25mm
	301130-0200	M20 x 2.50	17.5mm	135mm	40mm	35mm
	301130-0240	M24 x 3.00	21mm	148mm	45mm	40mm
<b>Inch</b>	301140-0001	1/2-13 UNC	27/64"	4 -23/32"	1-3/8"	1"
	301140-0002	5/8-11 UNC	17/32"	5-1/8"	1-29/64"	1"
	301140-0003	3/4-10 UNC	21/32"	5-33/64"	1-37/64"	1-3/8"
	301140-0005	1-8 UNC	7/8"	6-19/64"	1-49/64"	1-37/64"



## FEATURES & BENEFITS

## QUICK GUIDE

- Fast tapping with minimal kickback
- Specially hardened for use with Impact tools
- Automatic chip clearance when Impact tapping
- High grade tool steel for high accuracy & long life
- GoldMax low friction Titanium coating to stop burn out

- Correct RPM is critical for good performance on larger DrillTaps
- Ideal for use in Pillar Drills and Magnet Drills
- Pilot drilling with a separate bit is necessary when using DrillTap with Impact Wrenches
- Use appropriate lubrication & correct RPM to achieve long tool life

Find more info online



Watch the video YouTube



"I can certainly recommend the drill taps. These are absolutely amazing, no messing around changing between a drill bit and then tapping. The drill tap will save you no end of time and will last too."

MSA Fabrication Instagram

## POWERTOOL RECOMMENDATIONS ON MILD STEEL

**Impact Wrenches**  
Possible use up to M24  
Adapter P.12

**Reversible Magnetic Drills**  
Optimal performance: Up to M24  
Adapter P.13

**Pillar Drills**  
Optimal performance: Up to M24  
Adapter P.15

**SDS+ Drills**  
Not Recommended

**Impact Drivers**  
Not recommended

**Cordless Drills**  
Not recommended

## DETAILED TECHNICAL ADVICE & RPM GUIDE - P.97



**Recommended Powertool**

**Magnet Drill**

## NEW InsertFoil Sets

Compatible with the VersaDrive **STAKIT** system

See pages 48 - 53

301130-SET1	4 pcs	M12, M16, M20, M24
301140-SET1	4 pcs	1/2, 5/8, 3/4, 1"



\*STAKIT cases sold separately

11mm VersaDrive Shank

The VersaDrive Drillsink is an innovative combined drilling & countersinking tool to save metalworkers time & increase hole accuracy by drilling & then countersinking fixing holes in one operation.

This combination tool provides perfect countersinking accuracy every time by locating the drilled hole in perfect alignment to the countersink. This helps prevent tool chatter and blunting commonly found with standard countersinks.

VersaDrive Drillsinks have a patented non-slip, Hex shank suitable for use in any standard 1/2" drill chuck for Pistol Drills or used with a VersaDrive Rapid Lock adapter for use in a wide range of powertools such as Magnetic Drills.



## FEATURES & BENEFITS

## QUICK GUIDE

- Drill & countersink in one easy operation
- Perfect concentricity for perfect countersinking
- Ground flutes for high accuracy & long life
- High grade tool steel
- Prevents the chattering of standard countersinks
- GoldMax low friction Titanium coating to stop burn out

- Optimum life & performance when used with cordless drills & mag drills
- Can be used with Impact tools up to 16.5mm
- Suitable for use on harder materials like Stainless Steel when used at reduced RPM
- Use appropriate lubrication & correct RPM to achieve long tool life

Find more info online



Watch the video YouTube



## POWERTOOL RECOMMENDATIONS ON MILD STEEL

## DETAILED TECHNICAL ADVICE & RPM GUIDE - P.99

**Impact Drivers**  
Possible use up to 16.5mm countersink size  
Adapter P.12

**Impact Wrenches**  
Possible use up to 16.5mm countersink size  
Adapter P.12

**Magnetic Drills**  
Optimal performance: Up to 25mm countersink size  
Adapter P.13

**Cordless Drills**  
Optimal performance: Up to 25mm countersink size  
Adapter P.14

**SDS+ Drills (Rotary only mode)**  
Possible use up to 25mm countersink size  
Adapter P.14

**Pillar Drills**  
Optimal performance: Up to 25mm countersink size  
Adapter P.15



Recommended Powertool

Magnet Drill

	Part No	Ø D (mm)	Countersink Size (mm)	l1 (mm)	L (mm)	Countersunk Screw	CSK Angle
Metric	603070-08124	8	12.4	47	96	M6	90°
	603070-10165	10	16.5	47	85	M8	90°
	603070-11205	11	20.5	47	88	M10	90°
	603070-12205	12	20.5	47	88	M10	90°
	603070-13250	13	25	47	92	M12	90°
	603070-14250	14	25	47	92	M12	90°
Inch	603070-68165	6.8	16.5	47	85	M8 (Tapped)	90°
	603070-85205	8.5	20.5	47	89	M10 (Tapped)	90°
	603070-102250	10.2	25	47	93	M12 (Tapped)	90°

"Saved so much time with not only having to not switch tooling but also the way in which these tools cut through the metal with such ease. Even after 40+ holes still going strong."

Jon Powell  
J P Fabrications

## NEW InsertFoil Sets

Compatible with the VersaDrive STAKIT system

See pages 48 - 53

603070-SET4	4 pcs	8/12.4, 10/16.5, 12/20.5, 14/25mm
-------------	-------	-----------------------------------



\*STAKIT cases sold separately



The VersaDrive Countersink is a premium quality countersink with fully ground flutes and GoldMax Titanium coating to help reduce wear and blunting.

VersaDrive Countersinks have a patented non-slip, Hex shank suitable for use in any standard 1/2" drill chuck for cordless or Pistol Drills or used with a VersaDrive Rapid Lock adapter for use in a wide range of powertools such as Magnetic Drills.

Utilise the convenience and power of an Impact Wrench to quickly debur and countersink holes up to 16.5mm with minimal torque kick-back against the operator.



	Part No	ØD	Ød1	l1	L	Countersunk Screw	CSK Angle
Metric - 90°	603060-0063	6.3mm	1.5mm	17mm	45mm	M3	90°
	603060-0083	8.3mm	2.0mm	22mm	50mm	M4	90°
	603060-0104	10.4mm	2.5mm	22mm	50mm	M5	90°
	603060-0124	12.4mm	2.8mm	28mm	56mm	M6	90°
	603060-0165	16.5mm	3.2mm	32mm	60mm	M8	90°
	603060-0205	20.5mm	3.5mm	35mm	63mm	M10	90°
	603060-0250	25mm	3.8mm	39mm	67mm	M12	90°
	603060-0310	31mm	4.2mm	43mm	71mm	M16	90°

	Part No	ØD	Ød1	l1	L	Countersunk Screw	CSK Angle
Inch - 82°	603065-0100	1/4"	1/16"	7/64"	1-27/32"	-	82°
	603065-0200	3/8"	7/64"	5/32"	2-3/64"	-	82°
	603065-0300	1/2"	7/64"	7/32"	2-9/32"	-	82°
	603065-0400	5/8"	1/8"	9/32"	2-7/16"	-	82°
	603065-0500	3/4"	1/8"	11/32"	2-9/16"	-	82°
	603065-0600	1"	11/64"	31/64"	2-23/32"	-	82°



## FEATURES & BENEFITS

## QUICK GUIDE

- 1st Impact rated countersinks on the market
- Specially hardened for Impact use up to 16.5mm
- For countersunk bolt heads
- Safer use with minimal kickback
- High grade tool steel for high accuracy & long life
- GoldMax low friction Titanium coating to stop burn out
- Optimum life & performance when used with cordless drills & mag drills
- Can be used with Impact tools up to 16.5mm for fastest performance
- Suitable for use on harder materials when used at reduced RPM
- Not for use on plasma or flame cut holes
- Use appropriate lubrication & correct RPM to achieve long tool life

Find more info online



Watch the video YouTube



## POWERTOOL RECOMMENDATIONS ON MILD STEEL

## DETAILED TECHNICAL ADVICE & RPM GUIDE - P.100

**Impact Drivers**  
Possible use up to 16.5mm  
Adapter P.12

**Impact Wrenches**  
Possible use up to 16.5mm  
Adapter P.12

**Magnetic Drills**  
Optimal performance: Up to 31mm  
Adapter P.13

**Cordless Drills**  
Optimal performance: Up to 20.5mm  
Possible use up to 31mm

**SDS+ Drills (Rotary only mode)**  
Possible use up to 31mm  
Adapter P.14

**Pillar Drills**  
Optimal performance: Up to 31mm  
Adapter P.15

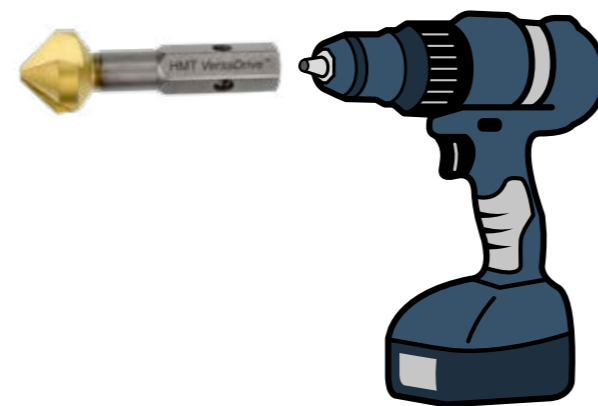

## Recommended Powertool

# Cordless Drill

## NEW InsertFoil Sets

Compatible with the VersaDrive **STAKIT** system

See pages 48 - 53

603060-5SET	5 pcs	12.4, 16.5, 20.5, 25, 31mm - 90°
603065-5SET	5 pcs	3/8, 1/2, 5/8, 3/4, 1" - 82°



\*STAKIT cases sold separately

VersaDrive reamers are the perfect hole alignment and enlarging tool for metalworkers & steel erectors for keeping the job moving when a hole is misaligned or the incorrect size for the fixing.

Featuring a specially designed 6 flute cutting geometry and Titanium coating, VersaDrive Reamers are fully Impact rated and perform fastest when used with an Impact Wrench providing ultimate cutting performance with virtually no powertool kickback.

VersaDrive Reamers have a patented non-slip, Hex shank suitable for use in any standard 1/2" drill chuck for Pistol Drills or used with a VersaDrive Rapid Lock adapter for use in a wide range of powertools such as Magnetic Drills.



### FEATURES & BENEFITS

### QUICK GUIDE

- Precision 6-flute design for smooth cutting
- Safer reaming with minimal kickback
- Specially hardened for use with Impact tools
- High grade tool steel for high accuracy & long life
- High strength, non-slip shank design
- GoldMax low friction Titanium coating to stop burn out

- For fastest performance use on Impact Wrenches & Impact Drivers
- Not recommended for Impact use with flame, plasma or laser cut holes
- For flame, plasma or laser cut holes use with a Magnet Drill
- Reamer should be rotating before starting the cut & steady feed pressure used throughout

Find more info online



Watch the video YouTube



### POWERTOOL RECOMMENDATIONS ON MILD STEEL

### DETAILED TECHNICAL ADVICE & RPM GUIDE - P.98

**Impact Drivers**  
Optimal performance: Up to 12mm  
Adapter P.12

**Impact Wrenches**  
Optimal performance: Up to 26mm  
Adapter P.12

**Magnetic Drills**  
Possible use up to 26mm  
Adapter P.13

**Cordless Drills**  
Optimal performance: Up to 12mm  
Possible use up to 14mm

**SDS+ Drills (Rotary only mode)**  
Possible use up to 12mm  
Adapter P.14

**Pillar Drills**  
Optimal performance: Up to 26mm  
Adapter P.15

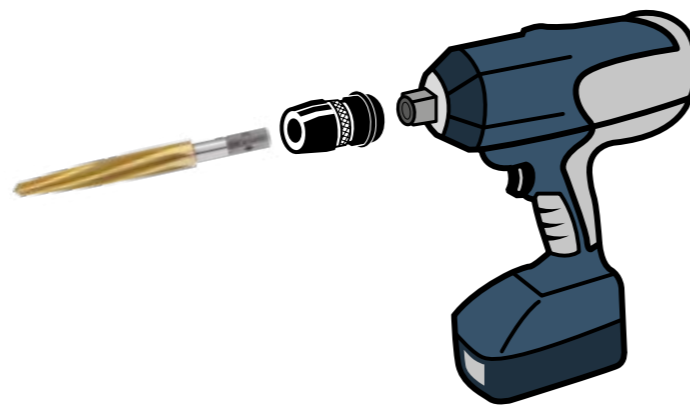

## Recommended Powertool Impact Wrench

	Part No.	ØD	Ød1	l1	l2	L
Metric	501030-0080	8mm	4.4mm	34mm	36mm	108mm
	501030-0100	10mm	6mm	34mm	36mm	108mm
	501030-0120	12mm	7.1mm	43mm	59mm	144mm
	501030-0140	14mm	7.5mm	52mm	50mm	144mm
	501030-0160	16mm	8.0mm	58mm	56mm	152mm
	501030-0180	18mm	9.4mm	58mm	56mm	170mm
	501030-0200	20mm	11.2mm	61mm	65mm	178mm
	501030-0210	21mm	12.3mm	61mm	66mm	185mm
	501030-0220	22mm	13.2mm	61mm	66mm	185mm
	501030-0240	24mm	15.1mm	62mm	66mm	185mm
501030-0260	26mm	15.9mm	63mm	66mm	185mm	

	Part No.	ØD	Ød1	l1	l2	L
Inch	501040-0040	1/2" (12.7mm)	19/64"	1-15/16"	2-1/16"	5 1/2"
	501040-0050	9/16" (14.3mm)	9/32"	2-1/16"	1-15/16"	5 1/2"
	501040-0060	5/8" (15.9mm)	5/16"	2-11/64"	2-21/64"	6"
	501040-0070	11/16" (17.5mm)	3/8"	2-1/4"	2-1/4"	6"
	501040-0080	3/4" (19.05mm)	13/32"	2-31/64"	2-33/64"	7"
	501040-0085	13/16" (20.63mm)	15/32"	2-33/64"	2-31/64"	7"
	501040-0090	7/8" (22.2mm)	17/32"	2-19/32"	2-13/32"	7"
	501040-0100	15/16" (23.8mm)	19/32"	2-43/64"	2-21/64"	7"
	501040-0110	1" (25.4mm)	5/8"	2-43/64"	2-21/64"	7"
	501040-0120	1-1/16" (27mm)	45/64"	2-9/16"	2-7/16"	7"

"These reamers have saved me literally hours and hours of work. They are a life saver on site"

J3weld\_fab  
Instagram

### NEW InsertFoil Sets

Compatible with the VersaDrive **STAKIT** system

See pages 48 - 53

501030-3SET	3 pcs	14, 18, 22mm
501030-5SET	5 pcs	12, 14, 18, 22, 26mm
501040-3SET	3 pcs	1/2, 5/8, 3/4"
501040-5SET	5 pcs	1/2, 5/8, 3/4, 7/8, 1-1/16"



\*STAKIT cases sold separately

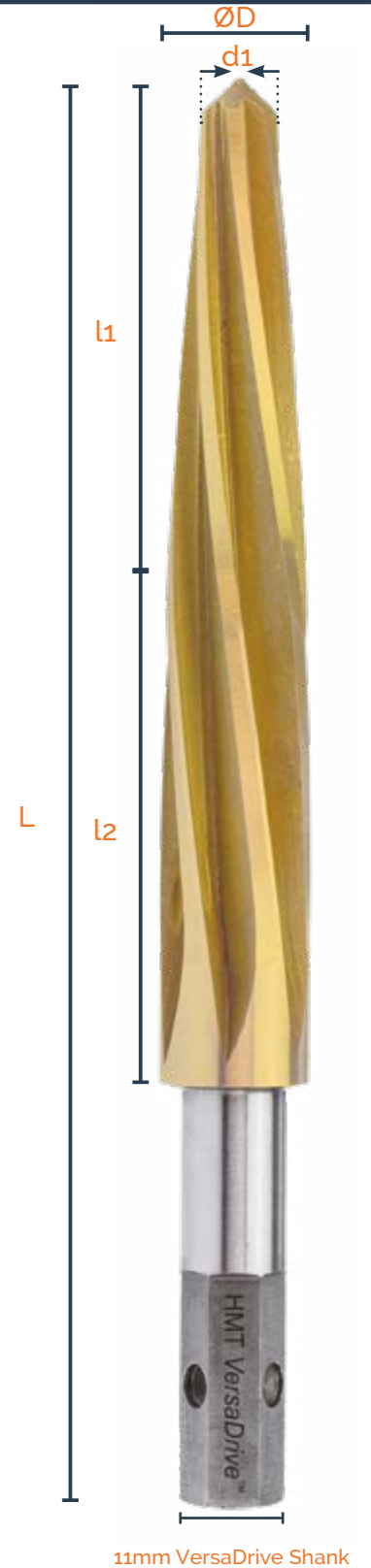

11mm VersaDrive Shank

# VERSADRIVE<sup>®</sup> MAX

The VersaDrive MAX new product range develops the patented VersaDrive shank into new territory for the most demanding industrial applications.

The standard VersaDrive Shank measures 11mm (AF)

The new heavy-duty VersaDrive MAX shank is 20mm (AF) meaning it can be used in far higher torque applications.



## HEAVY DUTY SHANK

This increased shank strength means that VersaDrive MAX can be used to power larger diameter cutting tools, for example 41mm diameter reamers and M42 Taps.

## VERSADRIVE<sup>®</sup> PATENT PROTECTED

(Images below are to scale)



## VERSADRIVE<sup>®</sup> MAX

DETAILED TECHNICAL ADVICE & RPM GUIDE - P.98



Tested on 50mm thick structural steel with 1" Milwaukee Impact Wrench & MT5 magnetic drilling machines



Impact Wrenches



Magnet Drills

## VersaDrive MAX Reamers

NEW

## IMPACT RATED

VersaDrive MAX reamers offer a heavy duty solution for enlarging and aligning holes in thick metal plate (e.g. 20mm and above) or at large diameters.

Specially designed cutting geometry and a unique 20mm shank mean they can be used with high torque Impact Wrenches and the most powerful Magnet Drills for superior performance and portability, allowing the job to be completed onsite and not removed for reworking.



### FEATURES & BENEFITS

- Ideal for steel erection & bridge work
- Ideal for modifying & enlarging holes
- Use with high torque Impact Wrenches & high power, low speed Magnetic Drills
- Unique 6 flute design for a faster, smoother cut
- Prepare holes ready for TCB & friction grip bolts
- Use with 1/2", 3/4" & 1" drive high power Impact Wrenches (1" drives require step-down adapter)

	Part No.	ØD (mm)	Ød1 (mm)	l1 (mm)	l2 (mm)	L (mm)
Metric	501050-0180	18	12	58	73	181
	501050-0220	22	15	66	85	201
	501050-0240	24	16	72	94	216
	501050-0260	26	18	72	94	216
	501050-0280	28	19	90	120	240
	501050-0300	30	21	90	100	240
	501050-0320	32	23	95	110	260
	501050-0330	33	24	95	110	260
	501050-0360	36	25	110	120	285
	501050-0390	39	27	110	120	285
	501050-0410	41	30	110	140	300



### VERSADRIVE MAX ADAPTERS

NEW

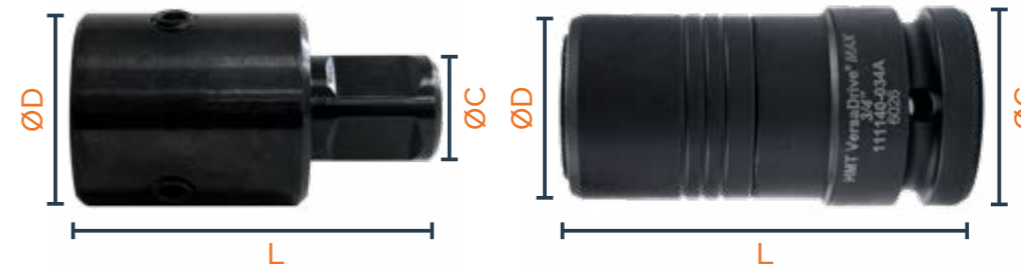

Part No	Drive Type	Drive Size	ØD (mm)	ØC (mm)	L (mm)
111031-01	Weldon	19.05mm (3/4")	34	19.05mm	63
111031-02	Weldon	31.75mm (1-1/4")	34	32mm	80
111140-012A	Impact	1/2" Drive	35	30	65
111140-034A	Impact	3/4" Drive	35	38	75
111140-SD1	StepDown Adapter	Converts 111140 3/4" adapter to fit 1" Impact Wrench			

• Impact adapters supplied with retention pin & ring

20mm VersaDrive Shank

# TCT HOLECUTTER<sup>®</sup>

TUNGSTEN CARBIDE TECHNOLOGY

10x LONGER LIFE

Fast, efficient & cost effective  
Outperforms & outlasts traditional HSS holesaws by up to 10 times!

VersaDrive TCT HoleCutters offer a fast, efficient and cost effective holemaking solution that outperform and outlast traditional HSS holesaws by up to 10 times!

Highly versatile and perfect for heavy duty applications VersaDrive HoleCutters are compatible with the VersaDrive system of extensions and adapters and feature cutting teeth manufactured from premium-grade Tungsten Carbide, one of the strongest materials for cutting tools. This ensures the highest levels of performance and durability, with faster cuts and increased life spans.

A complete hole cutting solution, the range offers Standard HoleCutters, Extra Long HoleCutters & the HMT exclusive HoleCutter and MultiSink combination.



### SPRING LOADED PILOT DRILL

Centres and stabilises cutter during drilling & ejects metal slug upon completion

### RAPID-LOCK SHANK

VersaDrive Hex shank fits all standard drill chucks, Rapid-lock adapters and extension arbors, offering the greatest flexibility & applications from a single tool.

### TUNGSTEN CARBIDE TEETH

Premium grade Sandvik Tungsten Carbide teeth for the highest performance cutting & 10x greater life than standard holesaws.

## THE RANGE

### THE COMPLETE SOLUTION

VersaDrive HoleCutters offer the widest range of hole cutting solutions on the market.

Our flagship TCT HoleCutter is the ideal choice for inaccessible and heavy duty holemaking challenges.

For specialist jobs that require extended depth drilling our innovative Extra Long HoleCutters offer a 100mm cutting depth.

Meanwhile all VersaDrive HoleCutters can be combined with the HMT exclusive multiSink system, allowing you to broach and countersink in one pass, as well as the complete range of VersaDrive Rotary adapters for use on Magnetic & SDS+ drills.

### SIZES AVAILABLE

#### Standard HoleCutter:

Diameter (Ø) : 12mm - 80mm

Cutting Length (L) : 55mm

Total Length: 100mm

#### Extra Long HoleCutter:

Diameter (Ø) : 14mm - 26mm

Cutting Length (L) : 100mm

Total Length: 149mm

#### HoleCutter & MultiSink:

HoleCutter (Ø) : 16mm - 26mm

MultiSink (Ø): 40 / 55mm

Total Length: 109mm

### REPLACING Magnet Drills

Many steel erectors and fabricators tell us that they are able to replace heavy and awkward magnetic drills with a standard cordless drill fitted with a VersaDrive hole cutter.

- No risk of a heavy Magnet Drill falling from height
- Quick to position and drill
- Carry less equipment, saving weight and increasing mobility

Watch the video



## 1 HOLECUTTER - 3 SOLUTIONS

-When using with a Magnet Drill adapter or MultiSink tool replace supplied pilot drill with 101030P-0003 ejector pin

### HoleCutter products available



Standard HoleCutter



Extra Long HoleCutter



HoleCutter with TCT MultiSink



HoleCutter upgrade kit



Use in Pistol Drill



Adapt for Magnet Drill Use



Adapt to MultiSink

VersaDrive TCT HoleCutters are a high performance solution for cutting larger diameter holes quickly and effectively. Premium grade Tungsten Carbide teeth provide ultimate cutting performance in a wide range of metals including Stainless Steel and Cast Iron.

THE go-to solution for fabricators and steel erectors needing to drill through heavy steel in locations & on projects where a rotary drill is more convenient & safer than a magnetic drill.

VersaDrive HoleCutters have a patented non-slip, Hex shank suitable for use in any standard 1/2" drill chuck and can be used with VersaDrive Rapid Lock adapters for use in a wide range of powertools such as Magnet Drills.



## FEATURES & BENEFITS

## QUICK GUIDE

- Massive 70mm reach with 55mm depth of cut
- Premium quality Tungsten Carbide teeth
- Perfect for drilling heavy steel in remote locations
- Use in standard 1/2" drill chuck
- Use with Magnet Drill adapter
- One piece design includes arbor & (replaceable) pilot drill
- Combine with MultiSink to broach & countersink in 1 pass

- Optimum life and performance when used with Rotary Pistol Drills
- Good results can be achieved with SDS Drills in Rotary only mode
- Replace supplied pilot drill with 101030P-0003 ejector pin to use with Magnet Drill / Multisink
- Suitable for use on Stainless Steel

Find more info online



Watch the video on YouTube



## POWERTOOL RECOMMENDATIONS ON MILD STEEL

## DETAILED TECHNICAL ADVICE & RPM GUIDE - P.91



**Cordless Drills**

Optimal performance: Up to 32mm

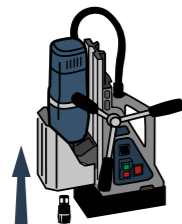

**Magnetic Drills**

Possible use up to 80mm  
Adapter P.13

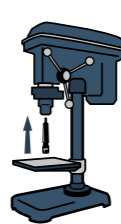

**Pillar Drills**

Optimal performance: Up to 80mm  
Adapter P.15

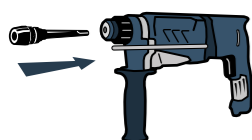

**SDS+ Drills**

(Rotary only mode)  
Possible use up to 22mm  
Adapter P.14

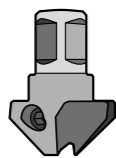

**Multisink**

Optimal performance: from 16-26mm  
Adapter P.15

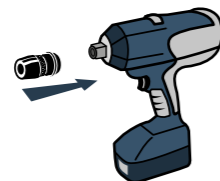

**Impact Tools**

Not recommended

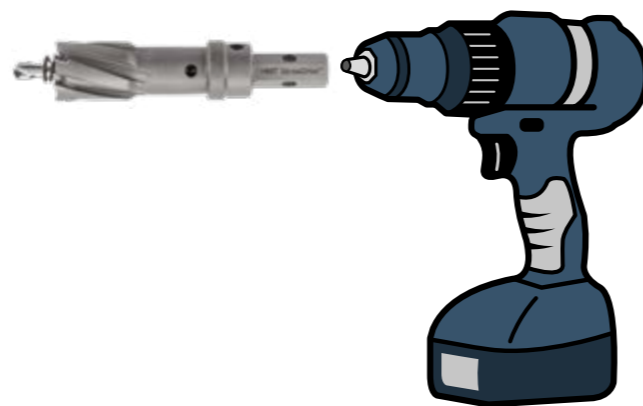

## Recommended Powertool

## Cordless Drill

Part No	ØD mm	ØD Inch	Grub Screw
101030-0120	12mm		M5
101030-0130	13mm		M5
101030-0140	14mm	9/16"	M5
101030-0150	15mm		M5
101030-0160	16mm	5/8"	M5
101030-0170	17mm	11/16"	M6
101030-0175	17.5mm		M6
101030-0180	18mm		M6
101030-0190	19mm	3/4"	M6
101030-0200	20mm		M6
101030-0210	21mm	13/16"	M8
101030-0220	22mm	7/8"	M8
101030-0230	23mm		M8
101030-0240	24mm	15/16"	M8
101030-0250	25mm	1"	M8
101030-0260	26mm		M8
101030-0270	27mm	1-1/16"	M8
101030-0280	28mm		M8
101030-0290	29mm	1-1/8"	M8
101030-0300	30mm	1-3/16"	M8
101030-0310	31mm		M8
101030-0320	32mm	1-1/4"	M8
101030-0330	33mm	1-5/16"	M8
101030-0340	34mm		M8
101030-0350	35mm	1/3-8"	M8
101030-0360	36mm		M8
101030-0370	37mm	1-7/16"	M8
101030-0380	38mm	1-1/2"	M8
101030-0390	39mm	1-9/16"	M8
101030-0400	40mm		M8
101030-0410	41mm	1-5/8"	M8
101030-0420	42mm		M8
101030-0430	43mm	1-11/16"	M8
101030-0440	44mm	1-3/4"	M8
101030-0450	45mm		M8
101030-0460	46mm	1-13/16"	M8
101030-0470	47mm		M8
101030-0480	48mm	1-7/8"	M8
101030-0490	49mm		M8
101030-0500	50mm		M8
101030-0510	51mm	2"	M8
101030-0520	52mm	2-1/16"	M8
101030-0550	55mm	2-5/32"	M8
101030-0600	60mm	2-3/8"	M8
101030-0650	65mm	2-9/16"	M8
101030-0700	70mm	2-3/4"	M8
101030-0750	75mm		M8
101030-0800	80mm	3-5/32"	M8



101030P-0130 Pilot Drill for 12 & 13mm HoleCutters (2pk) (Supplied WITHOUT ejection spring)

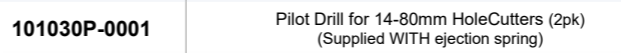

101030P-0001 Pilot Drill for 14-80mm HoleCutters (2pk) (Supplied WITH ejection spring)



101030P-0003 VersaDrive HoleCutter Magnet Broaching/MultiSink Pilot Pin, (2pk)

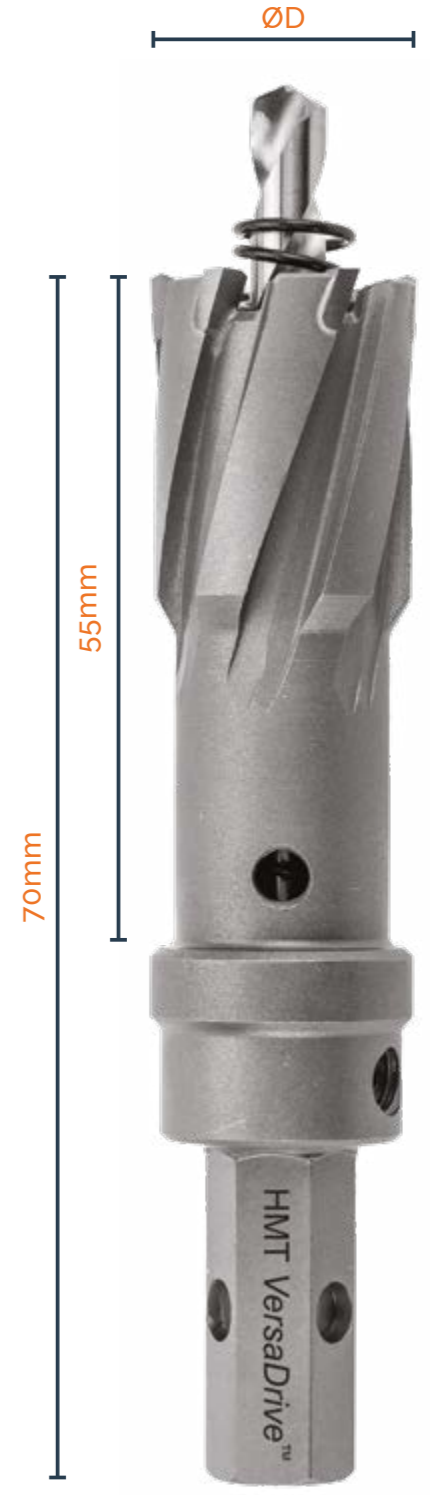

TurboTip pilot drill upgrade for added performance on thick materials  
Solid steel pilot pin prevents snagging & snapping while drilling thick materials

HoleCutter Upgrade Kit	
101030P-0004	VersaDrive TCT Holecutter Upgrade Kit 1 x TurboTip 1/4" / 6.35mm & 1 x Pilot Pin

NEW STAKIT Compatible Sets See page 47

Extra Long reach version of the popular VersaDrive HoleCutter. Perfect for small diameter drilling through steelwork using a Pistol Drill where a separate extension isn't practical.

Ideal for applications where a metal plate is encountered amongst wood joists or where both sides of a steel beam require drilling.

These are rapidly becoming the go-to solution for fabricators and steel erectors needing to drill through heavy steel in locations and on projects where a rotary drill is more convenient and safe than a magnetic drill.



## FEATURES & BENEFITS

## QUICK GUIDE

- 120mm reach with 100mm depth of cut
- Premium quality Tungsten Carbide teeth
- Perfect for drilling box section with inaccessible sides
- Use in standard 1/2" drill chuck
- Use with Magnet Drill adapter
- One piece design includes arbor & (replaceable) pilot drill

- Optimum life and performance when used with Rotary Pistol Drills
- Good results can be achieved with SDS Drills in Rotary only mode
- Replace supplied pilot drill with 101035P-02 ejector pin to use with Magnet Drill / Multisink
- Suitable for use on Stainless Steel

Find more info online



Watch the video on YouTube



## POWERTOOL RECOMMENDATIONS ON MILD STEEL

## DETAILED TECHNICAL ADVICE & RPM GUIDE - P.91



### Cordless Drills

Optimal performance: Up to 32mm

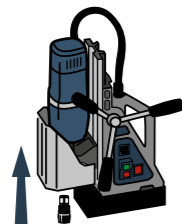

### Magnetic Drills

Possible use up to 80mm

Adapter P.13

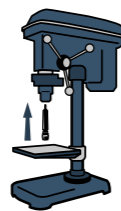

### Pillar Drills

Optimal performance: Up to 80mm

Adapter P.15

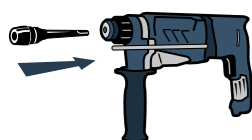
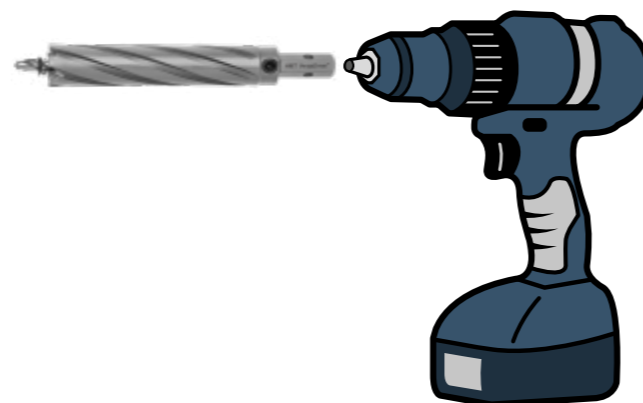

### SDS+ Drills (Rotary only mode)

Possible use up to 22mm

Adapter P.14

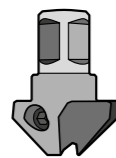

### Multisink

Optimal performance: from 16-26mm

Adapter P.15

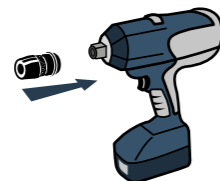

### Impact Tools

Not recommended

## Recommended Powertool

## Cordless Drill

Part No	ØD mm	ØD Inch	Grub Screw
101035-0140	14mm	9/16"	M5
101035-0170	17mm	11/16"	M6
101035-0180	18mm		M6
101035-0200	20mm		M6
101035-0210	21mm	13/16"	M8
101035-0220	22mm	7/8"	M8
101035-0240	24mm	15/16"	M8
101035-0260	26mm		M8



Pilot Drill Bits & Pins	
101035P-01	HMT VersaDrive Extra Long TCT HoleCutter Pilot Drills 6.35x165mm, (2pk)
101035P-02	HMT Extra Long VersaDrive HoleCutter Guide Pin 6.35x205mm, (2pk)

"We don't need the magdrill on site any more. So versatile, so easy, massive time saver."

Duncan Platford  
LinkedIn

## NEW InsertFoil Sets

Compatible with the VersaDrive STAKIT system

See pages 48 - 53

101030 HoleCutters - 55mm cutting depth		
101030-SET1	3 pcs	14, 18, 22mm
101030-SET2	5 pcs	14, 17, 18, 21, 22mm
101035 HoleCutters - 100 cutting depth		
101035-SET1	5 pcs	14, 18, 20, 24, 26mm



\*STAKIT cases sold separately

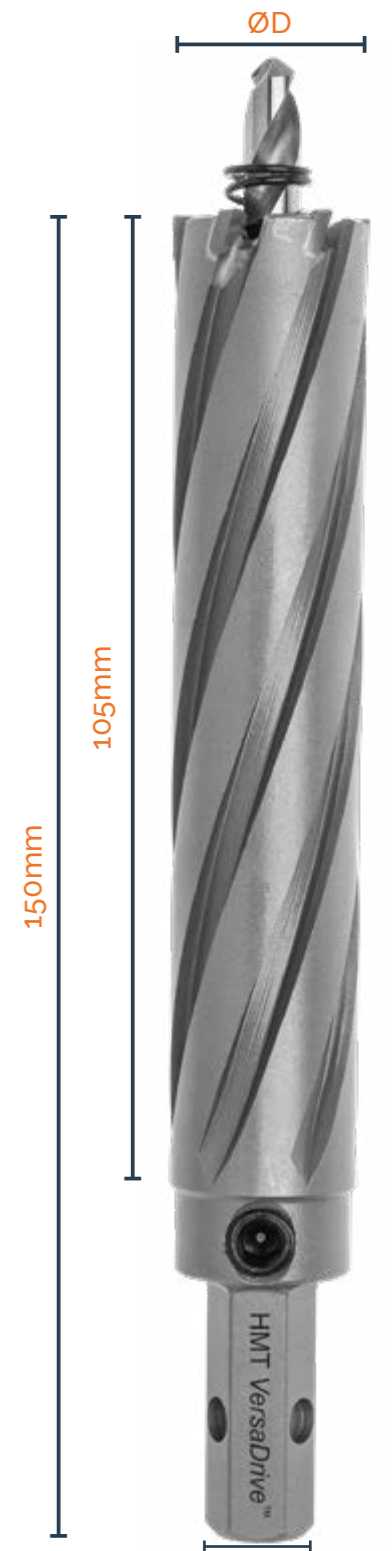

11mm VersaDrive Shank



# STAKIT InsertFoam

## Modular, customisable, tooling storage

The **InsertFoam** system is an innovative new addition to the **STAKIT** Storage system. Modular and customisable tool case storage to easily and efficiently organise your most important cutting tool sets.

HMT Cutting tool kits are now supplied in foam Inserts compatible with **VERSADRIVE STAKIT** Top cases.

There are 2 sizes of insert - Small & Large

Tooling is supplied in the insert best suited to the tool size and number of pieces in the set.



### How does it work?

1. Sets are supplied in a protective outer sleeve as shown below.
2. Remove the set from its sleeve
3. Choose a Top case - Available in 2 sizes (**See below**)
4. Insert foam into Top case and fit to the rest of your **STAKIT** system.

**N.B. Empty foams can be purchased for storage of existing VersaDrive or CarbideMax tooling**



1.



2.



3.

## STAKIT Half Top Case - MKC-ETOP2

The **STAKIT** Half Top case holds

- 1 x Large InsertFoam
- or
- 2 x Small InsertFoams



## STAKIT Top Case - MKC-ETOP4

The **STAKIT** Top case holds

- 2 x Large InsertFoam
- or
- 4 x Small InsertFoams
- or
- 2 x Small & 1 x Large InsertFoam



## VersaDrive STAKIT Half Top Case

The new **STAKIT** Half Top Case takes either

- 1 x Large InsertFoam
- or
- 2 x Small InsertFoams

Customisable to each application, these sets can grow as you add to your **STAKIT** system.

This case will clip to other Top cases or onto any EMID box

**L x W x H (mm) 270 x 370 x 95**

Part No	Product
MKC-ETOP2	VersaDrive <b>STAKIT</b> Half Top Case



## VersaDrive STAKIT Full Top Case

The **STAKIT** Top Case takes either

- 2 x Large InsertFoams
- or
- 4 x Small InsertFoams
- or
- 1 x Large Insert Foam & 2 x Small InsertFoams

Customisable to each application, these sets can grow as you add to your **STAKIT** system.

This case will clip to other Top cases or onto any EMID box

**L x W x H (mm) 540 x 390 x 95**

Part No	Product
MKC-ETOP4	VersaDrive <b>STAKIT</b> Top Case - Empty
STC-ETOP4-F04	<b>STAKIT</b> Top Case + 3 foam inserts for VersaDrive Adapters



## STAKIT InsertFoams

### CarbideMax 40 Broach Cutters



Part No	Set contents	InsertFoam Size
108030-SET	14, 18, 22mm + 2 Pilots	Small
108030-5SET	12, 14, 18, 22, 26mm + 2 Pilots	Small

### CarbideMax 80 Broach Cutters



Part No	Set contents	InsertFoam Size
108010-SET	18, 22, 24, 26, 28, 30mm + 2 Pilots	Large

## VERSADRIVE® STAKIT

### CarbideMax 55 Broach Cutters



Part No	Set contents	InsertFoam Size
108020-SET	14, 18, 22mm + 2 Pilots	Small
108020-5SET	12, 14, 18, 22, 26mm + 2 Pilots	Small

### CarbideMax 110 Broach Cutters



Part No	Set contents	InsertFoam Size
108040-SET	14, 18, 22, 24, 26mm + 2 Pilots	Large

### STAKIT InsertFoam - Small



Part No	Compatible with	InsertFoam Size
SETFM-VSD-04	VersaDrive Step Drills 12, 22, 30 & 40mm	Small
SETFM-VSD-07	VersaDrive HoleCutters, ImpactaStep, Counter-sinks - 7 spaces	Small
SETFM-VSD-08	VersaDrive tools up to 105mm in length & 22mm diameter - 8 spaces	Small
SETFM-WLD-05	CarbideMax cutters up to 100mm in length & 26mm diameter - 5 spaces	Small

### STAKIT InsertFoam - Large



Part No	Compatible with	InsertFoam Size
SETFM-LS-06	VersaDrive & CarbideMax tools up to 195mm in length and 26mm in diameter - 6 spaces	Large

### CarbideMax ULTRA Broach Cutters



Part No	Set contents	InsertFoam Size
108070-SET2	18, 20, 22, 24, 26mm + 2 Pilots	Small

### VersaDrive ULTRA Drill Bits



Part No	Set contents	InsertFoam Size
209020-SET1	6, 8, 10, 12, 14mm	Small

## STAKIT InsertFoams

### VersaDrive TCT HoleCutters



Sets include pilot drill bits

Part No	Set contents	InsertFoam Size
101030-SET1	14, 18, 22mm	Small
101030-SET2	14, 17, 18, 21, 22mm	Small

### VersaDrive ImpactaStep Sets



Enlarge holes in thick steel in seconds

Part No	Set contents	InsertFoam Size
506010-SET1	16, 22, 26mm	Small
506030-SET1	9/16, 13/16, 1-1/16"	Small

### VersaDrive TurboTip Sets



Drill at twice the speed with no pilot drilling needed

Part No	Set contents	InsertFoam Size
209015-SET1	6, 8, 10, 12mm	Small
209015-SET2	6, 7, 8, 9, 10, 11, 12mm	Small
209015-SET3	6.8, 8, 8.5, 10, 10.5, 12, 14mm	Small
209015-SET4	6, 8, 10, 12, 14, 18, 22mm	Small
209016-SET1	3/16, 1/4, 5/16, 1/2"	Small
209016-SET1	#7, F, 5/16, 27/64"	Small

## VERSADRIVE® STAKIT

### VersaDrive Extra Long TCT HoleCutters



Sets include pilot drill bits

Part No	Set contents	InsertFoam Size
101035-SET1	14, 18, 20, 24, 26mm	Large

### VersaDrive Step Drill Sets



Create holes in seconds

Part No	Set contents	InsertFoam Size
505020-SET1	12, 22, 30mm	Small
505020-SET2	12, 22, 30, 40mm	Small
505030-SET1	1/2, 7/8, 1-3/8"	Small

### VersaDrive Cobalt Drill Bit Sets



Premium grade 8% cobalt drill bits

Part No	Set contents	InsertFoam Size
209010-SET1	6, 8, 10, 12mm	Small
209010-SET2	5, 6.8, 8.5, 10.2mm	Small
209010-SET3	5, 6, 6.8, 8, 8.5, 10,	Small
209010-SET4	12, 13, 14, 16, 18, 20, 22mm	Small

## STAKIT InsertFoams

### VersaDrive ImpactaTap Sets



VersaDrive ImpactaTaps, 15x faster than hand tapping

Part No	Set contents	InsertFoam Size
308010-SET1	M6, M8, M10, M12, M16	Small
308010-SET2	M12, M16, M20, M24	Small
328015-SET1	TurboTip & ImpactaTap Combination Set 6.8, 8.5, 10.5, 14mm TurboTips M8, M10, M12, M16 ImpactaTaps	Small

### VersaDrive Heavy Duty DrillTap Sets



Drill and tap heavy duty, thick material in one easy operation

Part No	Set contents	InsertFoam Size
301130-SET1	M12, M16, M20, M24	Large
301140-SET1	1/2, 5/8, 3/4, 1" UNC	Large

### VersaDrive Countersink Sets



Quickly debur and countersink

Part No	Set contents	InsertFoam Size
603060-5SET	12.4, 16.5, 20.5, 25, 31mm 90°	Small
603065-5SET	3/8, 1/2, 5/8, 3/4, 1" 82°	Small

## VERSADRIVE® STAKIT

### VersaDrive DrillTap Sets



Drill and tap in one easy operation

Part No	Set contents	InsertFoam Size
301125-SET1	M5, M6, M8, M10, M12	Small
301126-SET1	1/4, 5/16, 3/8, 1/2" UNC	Small

### VersaDrive Drillsink Sets



Drill and countersink in one easy operation

Part No	Set contents	InsertFoam Size
603070-SET4	8/12.4, 10/16.5, 12/20.5, 14/25mm	Small

### VersaDrive Impact Reamer Sets



Enlarge or align connection holes

Part No	Set contents	InsertFoam Size
501030-3SET	14, 18, 22mm	Large
501030-SET	12, 14, 18, 22, 26mm	Large
501040-3SET	1/2, 5/8, 3/4"	Large
501040-5SET	1/2, 5/8, 3/4, 7/8, 1-1/16"	Large

# VERSADRIVE® STAKIT

## Total jobsite productivity with VersaDrive STAKIT

Keep the job moving and overcome unexpected job site challenges with these modular kits to speed up metalworking for install and maintenance teams.

VersaDrive® **STAKIT** is a new modular system of robust stacking site kits that give fast and easy transportation of your VersaDrive tooling & power tools to the jobsite.

Modular clip-together system so you can plug and play to choose the right package for your needs, or to start small and add more kits over time.

Each case can be used individually or interlocked for fast use in the field, on the jobsite or in the workshop.



Watch the video



### Features & Benefits

Waterproof & Dustproof

Store VersaDrive tooling

Protect your investment

Stacking & Interlocking

Store Magnet Drills

Easy equipment transportation

Durable, reinforced, injection moulded plastic

Store cordless power tools

Compatible with complete VersaDrive Range

## STAKIT Mid Toolcase - Lubricant Insert

The VersaDrive **STAKIT** Mid Case is a flexible tool and equipment storage case that also serves to connect the Top Toolcase to Base Cases or the **STAKIT** trolley.

The EMID-100-L version comes complete with:  
Foam insert for 1 x SpeedLube Aerosol Lubricant  
1 x Aeropaste Aerosol Lubricant  
2 x BioCut Paste Lubricant  
8 x Organiser boxes for tooling & accessories

The EMID-100-LF version includes the above plus lubricant.



L x W x H (mm) - 582 x 387 x 131



Part No	Contents
STC-EMID-100-L	<b>STAKIT</b> Mid Case w. Lubricant Insert & 8 x Organiser boxes (Lubricant not included)
STC-EMID-100-LF	<b>STAKIT</b> Mid Case w. Lubricant Insert, 8 x Organiser boxes & Lubricant

## STAKIT Mid Toolcase - Customisable Foam Insert

The MKC-EMID-200 version of the **STAKIT** Mid Case is completely self-customisable. It comes with removable foam inserts that fill the case and can be cut to hold power tools, batteries, chargers, tooling and anything else you will need on site.

Once cut to shape, the foam will hold and protect items inside, offering peace of mind and preventing damage to vital equipment in transit.



L x W x H (mm) - 582 x 387 x 131



Part No	Product
MKC-EMID-200	<b>STAKIT</b> Self-Customisable Mid Case

## STAKIT Steel Erector's Snagging Kit

NEW

## VERSADRIVE® STAKIT

The Steel Erector's Snagging Kit is a heavy duty site kit for hole creation, enlarging and aligning at all the most commonly required sizes.

Presented in an interlocking, stackable, and protective **STAKIT** Mid case, it includes CarbideMax Broach cutters and VersaDrive HoleCutters for hole creation, VersaDrive Reamers and ImpactaStep Cutters for hole enlarging and aligning and heavy duty VersaDrive adapters for 1/2" and 3/4" Impact wrenches. For tight access applications requiring additional reach, a 130mm VersaDrive extension arbor is also included.

### Kit Contents:

4 x HoleCutters 14, 18, 22, 26mm  
4 x Reamers 14, 18, 22, 26mm  
2 x ImpactaStep Cutters 22, 26mm  
4 x CarbideMax Broach Cutters 14, 18, 22, 26mm  
1/2" HD Impact Wrench adapter  
3/4" HD Impact Wrench adapter  
130mm Extension arbor

L x W x H (mm) - 582 x 387 x 131

Part No	Contents
STC-EMID-SEIK	VersaDrive <b>STAKIT</b> Steel Erector's Snagging Kit - Metric



## STAKIT 31pc Site Installation Kit

The **STAKIT** Site Installation Kit is created to combine an essential set of best-selling VersaDrive products to overcome all common site installation and steel erection holmaking challenges. Keeps the job moving when you find an unexpected challenge.

Presented in the **STAKIT** Mid Case and connects to all Top cases and Base cases.

### Metric Sized Kit Contents:

6 x TurboTips 6, 6.35, 8, 10.5, 12, 14mm  
5 x HoleCutters 14, 17, 18, 20 & 22mm  
2 x ImpactaStep 16 & 22mm  
3 x DrillTaps M6, M8 & M10  
3 x ImpactaTaps M12, M16 & M20  
4 x Reamers 12, 14, 18 & 22mm

### Inch Sized Kit Contents:

6 x TurboTips 1/4, 9/32, 5/16, 3/8, 7/16, 1/2"  
5 x HoleCutters 9/16, 5/8, 3/4, 7/8, 1"  
2 x ImpactaStep 9/16, 13/16"  
3 x DrillTaps 5/16, 3/8, 1/2"  
3 x ImpactaTaps 1/2, 5/8, 3/4"  
4 x Reamers 1/2, 9/16, 11/16, 13/16"

### + 5x Rapid lock adapters

1/4" Impact Driver Adapter, 1/2" Impact Wrench Adapter, Magnet Drill Adapter, 130mm Extension, 300mm Extension

L x W x H (mm) - 582 x 387 x 131

Part No	Contents
STC-EMID-MEIK	<b>STAKIT</b> 31pc Installation Kit - Metric
STC-EMID-INIK	<b>STAKIT</b> 31pc Installation Kit - Inch Sizes



## STAKIT SiteCart

The **STAKIT** SiteCart is a wheeled base unit with adjustable height handle and robust, water and dust proof construction.

The case can be used on its own for large equipment storage or combined with the rest of the **STAKIT** system to transport tooling and cases to and around the job site or workshop.

The case is designed to be tilted and pulled, has a handy narrow size and is easy to manoeuvre. Supplied empty.



L x W x H (mm) - 600 x 460 x 765

Part No	Product
STC-SITECART	<b>STAKIT</b> SiteCart

## VERSADRIVE® STAKIT



## STAKIT V60T Install SiteKit

NEW

## VERSADRIVE® STAKIT

The **STAKIT** V60T Install SiteKit dominates when it comes to improving efficiency, speeding up jobs & overcoming serious metalworking obstacles.

All the essential tooling and equipment needed to drill, broach, ream & tap the most common holes sizes is available where & when it is needed.

A powerful V60T VersaDrive magnet drill offers hole cutting up to 60mm diameter and 150mm depth, reaming up to 20mm, tapping up to M20 and countersinking to 40mm.

### Contents:

- 1 x **STAKIT** Site Installation Kit (p.55) (supplied in **STAKIT** Mid Case)
- 1 x VersaDrive V60T Magnet Drill (p.61) (Supplied in **STAKIT** Base 350 case)
- 1 x **STAKIT** SiteCart (p.56)



Part No	Product
STC-KIT-V60INS-110	<b>STAKIT</b> V60T Install SiteKit - 110v
STC-KIT-V60INS-230	<b>STAKIT</b> V60T Install SiteKit - 230v



## STAKIT Steel Erector's SiteKit

NEW

On-site snagging for steel erectors is made faster, easier and more efficient with the new **STAKIT** Steel Erector's SiteKit.

The SiteKit contains a range of best selling hole creation, enlarging and aligning tools at all the most commonly required sizes. Tight access work and beam drilling is made possible by the RTQ40 low profile magnet drill and a VersaDrive V35 magnet drill offers seamless integration with the VersaDrive cutting tool system and is perfect for over head drilling and working at height thanks to its lightweight and powerful motor. A Site Cart completes the kit allowing for transportation and additional storage.

### Contents:

- 1 x RTQ40 Low Profile Magnet Drill (**STAKIT** version) (p.64)
- 1 x VersaDrive V35 Magnet Drill (p.60) (supplied in **STAKIT** Base 200 case)
- 1 x Steel Erector's Snagging Kit (p.55) (supplied in **STAKIT** Mid Case)
- 1 x **STAKIT** SiteCart (p.56)



Part No	Product
STC-KIT-SES-110	<b>STAKIT</b> Steel Erector's SiteKit - 110v
STC-KIT-SES-230	<b>STAKIT</b> Steel Erector's SiteKit - 230v



## STAKIT V35 Install SiteKit

NEW

The VersaDrive **STAKIT** V35T Install SiteKit contains everything needed to get underway on site and overcome all the most common metalworking challenges. Whether you need to create holes, alter or tap them, the V35T Install SiteKit contains the tooling and equipment needed to complete the job quickly and efficiently.

As part of the kit a compact but high power V35 VersaDrive Magnet Drill ensures that wherever you go, you have access to lightweight, portable broaching and drilling capabilities.

### Contents:

- 1 x **STAKIT** Site Installation Kit (p.55) (supplied in **STAKIT** Mid Case)
- 1 x VersaDrive V35 Magnet Drill (p.60) (Supplied in **STAKIT** Base 200 case)
- 1 x **STAKIT** SiteCart (p.56)



Part No	Product
STC-KIT-V35INS-110	<b>STAKIT</b> V35 Install SiteKit - 110v
STC-KIT-V35INS-230	<b>STAKIT</b> V35 Install SiteKit - 230v



**VERSA DRIVE**<sup>®</sup>  
PATENT PROTECTED

## VersaDrive Industrial Magnetic Drills

Unique benefits from a unique range.

From the lightest, most compact machine on the market to machines with variable speed, variable torque and forward/reverse as standard, VersaDrive magnetic drills have been custom engineered to optimise performance.







Designed and built in our Sheffield factory by the expert HMT team, all machines with tapping capacity are powered by a legendary Eibenstock motor & combine with the Patented VersaDrive modular tooling system to extend consumable life and enhance performance for broaching, drilling, threading, countersinking & more.

When registered, products are protected by a

**2 YEAR WARRANTY**



### THE MOST COMPREHENSIVE MAGNET DRILL RANGE ON THE MARKET

-  *Drilling and broaching from 12 - 125mm*
-  *1000s of metalworking solutions*
-  *Drill, tap, ream, countersink and more...*
-  *Optimised for use with CarbideMax cutters for 64% faster broaching*
-  *Integrate seamlessly with the VersaDrive system*
-  *High performance, premium quality, UK built*

Watch the video



**MADE IN BRITAIN**<sup>®</sup> **UK CA**



Model	Max Cutter Diameter	Fitting	Weight (Kg)	Stroke	Drilling	Tapping	Countersinking
V35	35mm	19.05mm (3/4")	9.5kg	140mm	12mm	N/A	25mm
V60T	60mm	MT2	18kg	220mm	20mm	M20	40mm
V85T	85mm	MT3	20.5kg	220mm	27mm	M27	55mm
V100T	100mm	MT3	24.5kg	280mm	30mm	M30	55mm
V125T	125mm	MT3	25kg	280mm	32mm	M32	65mm

## VersaDrive V35 Magnet Drill

Most flexible compact Magnet Drill on the market

The HMT VersaDrive V35 is the first UK Built portable drilling machine designed for high-performance, low-maintenance, industrial quality drilling up to 35mm diameter. With a 140mm stroke, maximum cutter length of 110mm and seamless integration with the VersaDrive modular cutting system, it offers the most flexibility of any compact Magnet Drill on the market.

### Technical Specifications

<b>CUTTER SIZE RANGE</b>	12 - 35mm TCT	<b>WEIGHT</b>	9.5kg
<b>MAX CUTTER CAPACITY</b>	35mm	<b>MAGNET (L X W)</b>	160 x 80mm
<b>MAX CUTTER LENGTH</b>	110mm	<b>MAGNETIC ADHESION</b>	1000kg
<b>TWIST DRILL CAPACITY</b>	12mm	<b>MOTOR POWER</b>	850W
<b>COUNTERSINKING</b>	25mm	<b>TOTAL POWER</b>	900W
<b>REAMING</b>	N/A	<b>SPEED RPM (No Load)</b>	750
<b>MAX TAP CAPACITY</b>	N/A	<b>SPINDLE</b>	3/4" Weldon
<b>LENGTH</b>	220mm	<b>ARBOR</b>	Integral 3/4" Weldon
<b>WIDTH (Inc Handles)</b>	173mm	<b>COOLANT SYSTEM</b>	Gravity Oil Fed
<b>HEIGHT (Min-Max)</b>	305 - 445mm	<b>WARRANTY</b>	2 Year (When registered)
<b>STROKE</b>	140mm		



<b>850035-110</b>	HMT V35 VersaDrive Magnetic Drill Kit 110v
<b>850035-230</b>	HMT V35 VersaDrive Magnetic Drill Kit 230v
<b>850035-230EU</b>	HMT V35 VersaDrive Magnetic Drill Kit 230v EU Plug

## VersaDrive V35 Pipe Magnet Drill

NEW

The VersaDrive V35 Pipe Magnet Drill offers all the advantages of the standard V35 with the added benefit of a pipe compatible magnetic base.

Two switched permanent magnets are secured to swivelling mounting points and can be positioned as needed, allowing use on tubes and piping with a minimum diameter of 76.2mm. This also allows use on many contoured surfaces and internal use on large pipes.

Magnets can also be positioned horizontally to use as a standard machine on flat surfaces, making the V35 Pipe drill the most versatile compact machine on the market.

Supplied with a coolant fed arbor.

### Technical Specifications (Where different from standard V35)

<b>LENGTH</b>	275mm
<b>WIDTH (Inc Handles)</b>	185mm
<b>HEIGHT (Min-Max)</b>	330 - 470mm
<b>WEIGHT</b>	10.5kg
<b>MAGNET (L X W X H)</b>	187 x 165 x 83mm
<b>MAGNETIC ADHESION</b>	532kg

<b>850035-T-110</b>	HMT V35 PIPE Magnet Drill Kit 110V
<b>850035-T-230</b>	HMT V35 PIPE Magnet Drill Kit 230V

All V35s supplied with **STAKIT** Base case, VersaDrive Rapid-Lock adapter, handles, restraint strap, heavy duty metal guard & gravity fed coolant system.

VERSADRIVE  
PATENT PROTECTED

**140mm Stroke**  
**110mm Cutting depth**  
**Only 9.5kg**



## VersaDrive V60T Magnet Drill

VERSADRIVE  
PATENT PROTECTED

The HMT VersaDrive V60T is designed to meet a need in the market for a high-performance, low-maintenance, industrial quality portable drilling unit.

Delivers constant performance in the most challenging drilling environments and fabrication conditions. Supplied with a coolant fed arbor.

### Technical Specifications

<b>CUTTER SIZE RANGE</b>	12 - 60mm TCT	<b>WEIGHT</b>	18 kg
<b>MAX CUTTER CAPACITY</b>	60mm TCT	<b>MAGNET (L X W)</b>	200 x 100mm
<b>MAX CUTTER LENGTH</b>	150mm	<b>MAGNETIC ADHESION</b>	1750 kgs
<b>TWIST DRILL CAPACITY</b>	20mm	<b>MOTOR POWER</b>	1150w
<b>COUNTERSINKING</b>	40mm	<b>TOTAL POWER</b>	1270w
<b>REAMING</b>	20mm	<b>SPEED RPM (No Load)</b>	100 - 250 / 180 - 450
<b>MAX TAP CAPACITY</b>	M20	<b>SPINDLE</b>	MT2
<b>LENGTH</b>	315mm	<b>ARBOR</b>	19.05 mm (3/4") Weldon
<b>WIDTH (Inc Handles)</b>	220mm	<b>COOLANT SYSTEM</b>	Gravity Oil Fed
<b>HEIGHT (Min-Max)</b>	385 - 605mm	<b>WARRANTY</b>	2 Year (When registered)
<b>STROKE</b>	220mm		



<b>850060-P-110</b>	HMT V60T VersaDrive Magnetic Drill Kit - 110v
<b>850060-P-230</b>	HMT V60T VersaDrive Magnetic Drill Kit - 230v
<b>850060-P-230EU</b>	HMT V60T VersaDrive Magnetic Drill Kit 230V EU Plug

## VersaDrive V60T Pipe Magnet Drill

NEW

The VersaDrive V60T Pipe Magnet Drill offers all the advantages of the standard V60T with the added benefit of a pipe compatible magnetic base.

Two switched permanent magnets are secured to swivelling mounting points and can be positioned as needed, allowing use on tubes and piping with a minimum diameter of 80mm. This also allows use on many contoured surfaces and internal use on large pipes.

Magnets can also be positioned horizontally for use as a standard machine on flat surfaces.

Supplied with a coolant fed arbor.

### Technical Specifications (Where different from standard V60T)

<b>LENGTH</b>	320mm
<b>WIDTH (Inc Handles)</b>	220mm
<b>HEIGHT (Min-Max)</b>	415 - 635mm
<b>WEIGHT</b>	19kg
<b>MAGNET (L X W X H)</b>	266 x 239 x 82mm
<b>MAGNETIC ADHESION</b>	860kg

<b>850060-T-110</b>	HMT V60T PIPE Twin Magnet Drill Kit 110v
<b>850060-T-230</b>	HMT V60T PIPE Twin Magnet Drill Kit 230v

All V60Ts supplied with case, VersaDrive Rapid-Lock adapter, morse taper broaching arbor, handles, restraint strap, heavy duty metal guard & gravity fed coolant system.





## VersaDrive V85T Magnet Drill

The VersaDrive V85T combines light weight portability with high power, all-day broaching capability up to 85mm diameter. The powerful forward/reverse, variable speed, Eibenstock motor will tap holes up to M27 diameter. The V85T is also fully rated for reaming and countersinking. Advanced British electromagnets provide enhanced magnet hold for exceptional safety and stability. Supplied with a coolant fed arbor.

### Technical Specifications

<b>CUTTER SIZE RANGE</b>	12 - 85mm TCT	<b>WEIGHT</b>	20.5 kg
<b>MAX CUTTER CAPACITY</b>	85mm TCT	<b>MAGNET (L X W)</b>	200 x 100mm
<b>MAX CUTTER LENGTH</b>	150mm	<b>MAGNETIC ADHESION</b>	1750 kgs
<b>TWIST DRILL CAPACITY</b>	27mm	<b>MOTOR POWER</b>	1800w
<b>COUNTERSINKING</b>	55mm	<b>TOTAL POWER</b>	1920w
<b>REAMING</b>	24mm	<b>SPEED RPM (No Load)</b>	60 - 140 / 200 - 470
<b>MAX TAP CAPACITY</b>	M27	<b>SPINDLE</b>	MT3
<b>LENGTH</b>	325mm	<b>ARBOR</b>	19.05 mm (¾") Weldon
<b>WIDTH (Inc Handles)</b>	240mm	<b>COOLANT SYSTEM</b>	Gravity Oil Fed
<b>HEIGHT (Min-Max)</b>	425 - 645mm	<b>WARRANTY</b>	2 Year (When registered)
<b>STROKE</b>	220mm		



<b>850085-P-110</b>	VersaDrive V85T Magnetic Drill Kit 110v
<b>850085-P-230</b>	VersaDrive V85T Magnetic Drill Kit 230v
<b>850085-P-230EU</b>	Versadrive V85T Magnetic Drill Kit 230v EU Plug

**VERSADRIVE**  
PATENT PROTECTED



## VersaDrive V125T Magnet Drill

The VersaDrive V125T offers heavy duty, portable drilling up to 125mm diameter. An all day broaching capacity combines with powerful tapping capability up to M32 for both through & blind holes thanks to a powerful forward/reverse, variable speed, multi-gear Eibenstock motor. Advanced British electromagnets also provide enhanced magnet hold for exceptional safety and stability. Supplied with a coolant fed arbor.

### Technical Specifications

<b>CUTTER SIZE RANGE</b>	12 - 125mm TCT	<b>WEIGHT</b>	25 kg
<b>MAX CUTTER CAPACITY</b>	125mm TCT	<b>MAGNET (L X W)</b>	220 x 115mm
<b>MAX CUTTER LENGTH</b>	200mm	<b>MAGNETIC ADHESION</b>	2200 kgs
<b>TWIST DRILL CAPACITY</b>	32mm	<b>MOTOR POWER</b>	1800w
<b>COUNTERSINKING</b>	60mm	<b>TOTAL POWER</b>	1900w
<b>REAMING</b>	32mm	<b>SPEED RPM (No Load)</b>	60-140 / 100-220 / 140-310 / 210-490
<b>MAX TAP CAPACITY</b>	M32	<b>SPINDLE</b>	MT3
<b>LENGTH</b>	345mm	<b>ARBOR</b>	19.05 mm (¾") Weldon
<b>WIDTH (Inc Handles)</b>	240mm	<b>COOLANT SYSTEM</b>	Gravity Oil Fed
<b>HEIGHT (Min-Max)</b>	470 - 750mm	<b>WARRANTY</b>	2 Year (When registered)
<b>STROKE</b>	280mm		



<b>850125-P-110</b>	VersaDrive V125T Magnetic Drill Kit 110v
<b>850125-P-230</b>	VersaDrive V125T Magnetic Drill Kit 230v
<b>850125-P-230EU</b>	Versadrive V125T Magnetic Drill Kit 230v EU Plug

**VERSADRIVE**  
PATENT PROTECTED



## VersaDrive V100T Magnet Drill

The VersaDrive V100T offers high performance, low maintenance industrial drilling with an all-day broaching capacity up to 100mm diameter. Its powerful forward / reverse, variable speed, geared Eibenstock motor will tap holes up to M30 and can be used with the VersaDrive blind hole tapping system up to M30. The V100T is also fully rated for reaming and countersinking. Supplied with a coolant fed arbor.

### Technical Specifications

<b>CUTTER SIZE RANGE</b>	12 - 100mm TCT	<b>WEIGHT</b>	24.5 kg
<b>MAX CUTTER CAPACITY</b>	100mm TCT	<b>MAGNET (L X W)</b>	220 x 115mm
<b>MAX CUTTER LENGTH</b>	200mm	<b>MAGNETIC ADHESION</b>	2200 kgs
<b>TWIST DRILL CAPACITY</b>	32mm	<b>MOTOR POWER</b>	1800w
<b>COUNTERSINKING</b>	55mm	<b>TOTAL POWER</b>	1900w
<b>REAMING</b>	26mm	<b>SPEED RPM (No Load)</b>	60 - 140 / 200 - 470
<b>MAX TAP CAPACITY</b>	M30	<b>SPINDLE</b>	MT3
<b>LENGTH</b>	345mm	<b>ARBOR</b>	19.05 mm (¾") Weldon
<b>WIDTH (Inc Handles)</b>	240mm	<b>COOLANT SYSTEM</b>	Gravity Oil Fed
<b>HEIGHT (Min-Max)</b>	450 - 730mm	<b>WARRANTY</b>	2 Year (When registered)
<b>STROKE</b>	280mm		



<b>850100-P-110</b>	VersaDrive V100T Magnetic Drill Kit 110v
<b>850100-P-230</b>	VersaDrive V100T Magnetic Drill Kit 230v
<b>850100-P-230EU</b>	VersaDrive V100T Magnetic Drill Kit 230v EU Plug



## HMT Cordless Coolant Pump Kit (with magnetic foot)

NEW

4 Litre capacity, rechargeable cordless coolant pump with adjustable dispensing arm, magnetic foot and additional coolant supply outlet that can be connected to a magnet drill arbor. Use for both external flooding and through arbor cooling.

Dispensing arm provides hands-free, adjustable flow lubrication and cooling for otherwise difficult operations.

The magnetic foot can be secured to any magnetic surface for maximum flexibility of use when working at height, in tight, awkward locations or just where two hands are needed for the job and lubrication wouldn't otherwise be possible.

### Technical Specifications

<b>LENGTH</b>	320mm (Exc. dispensing arm)
<b>WIDTH</b>	155mm
<b>HEIGHT</b>	260mm
<b>WEIGHT</b>	950g (Empty)
<b>BATTERY</b>	2Ah
<b>BATTERY LIFE</b>	Up to 3hrs
<b>CAPACITY</b>	4 Litres



<b>103010-KIT</b>	4L Cordless Coolant Pump Kit
-------------------	------------------------------

V85, V100 & V125 are all supplied with a heavy duty site case, VersaDrive Rapid-Lock adapter, morse taper broaching arbor, handles, restraint strap, heavy duty metal guard & gravity fed coolant system.

## HMT RTQ40 Low Profile Magnet Drill

HOLEMAKER TECHNOLOGY  
**HMT**

The HMT RTQ40 is a low profile Magnet Drill for tight access applications. Designed to fit into any space greater than 180mm it is suitable for use with any standard broaching cutters but is optimised to work with the high-performance CarbideMax 40 cutters. The ratchet drive can be mounted on either side of the machine and its powerful motor and magnet give excellent stability.

### Technical Specifications

CUTTER SIZE RANGE	12-40mm
MAX CUTTER CAPACITY	40mm
TWIST DRILL CAPACITY	13mm
LENGTH	310mm
WIDTH	135mm
HEIGHT	180mm
STROKE	40mm
WEIGHT	10.8kg
MAGNET (L x W x H)	160x80x37mm
MAGNETIC FORCE	1200kg
MOTOR POWER	1050W
TOTAL POWER	1100W
SPEED RPM (No Load)	700RPM
SPINDLE	Quick change 19.05mm 3/4" Weldon arbor for all standard broaching cutters
COOLANT SYSTEM	Gravity Oil Fed
WARRANTY	1 Year



Supplied in  
**STAKIT Base 200 case**



Supplied in a **STAKIT** Base 200 case, with hex keys, restraint strap, ratchet and removable coolant system.

803084-110	RTQ40 Magnetic Drill 110v
803084-230	RTQ40 Magnetic Drill 230v

## HMT MAX40V Magnet Drill

The MAX40V offers a 145mm stroke and comfortably accommodates cutters up to 110mm for deep broaching. It also accepts the VersaDrive Rapid-Lock Weldon Adapter with VersaDrive tooling, opening up 1,000s of time saving solutions from the whole VersaDrive system.

### Technical Specifications

CUTTER SIZE RANGE	12 - 40mm TCT	WEIGHT	10.5 kg
MAX CUTTER LENGTH	110mm	MAGNET (L X W)	160 x 80mm
TWIST DRILL CAPACITY	16mm	MAGNETIC ADHESION	1500 kgs
COUNTERSINKING	25mm	MOTOR POWER	1150w
REAMING	12mm	SPEED RPM (No Load)	600 RPM
MAX TAP CAPACITY	N/A	SPINDLE	19.05 mm (3/4") Weldon
LENGTH	264mm	COOLANT SYSTEM	Gravity Oil Fed
WIDTH (Inc Handles)	180mm	WARRANTY	1 Year
HEIGHT (Min-Max)	360 - 440mm		
STROKE	145mm		



803046-110	HMT MAX40V Magnetic Drill 110v
803046-230	HMT MAX40V Magnetic Drill 230v



Supplied with a plastic case, hex keys, restraint strap, metal guard & removable coolant system.

## HMT MAX150T Magnet Drill

HOLEMAKER TECHNOLOGY  
**HMT**

NEW

The HMT MAX150T offers immense capacity for portable drilling, tapping and countersinking. Designed for heavy duty, industrial application, it tackles the most challenging metalworking tasks with its 2400W, high torque, variable speed, reversible motor.

### Technical Specifications

CUTTER SIZE RANGE	12-150mm	WEIGHT	42kg
MAX CUTTER LENGTH	200mm	MAGNET SIZE	270x135x70mm
MAX TWIST DRILL	46mm	MAGNETIC FORCE	2100kg
TAPPING RANGE	M42	POWER CONSUMPTION	2,400W
COUNTERSINKING	90mm	SPEED RPM (No Load)	60-80//125-165//205-275//410-545
REAMING	46mm	SPINDLE	MT4
LENGTH	390mm	ARBOR	31.75mm (1-1/4") Weldon
WIDTH INC HANDLES	210mm	COOLANT SYSTEM	Included
HEIGHT	630-930mm	WARRANTY	1 Year
STROKE	300mm		



803094-110	HMT MAX150T Magnet Drill 110v
803094-230	HMT MAX150T Magnet Drill 230v



## HMT MAX200T Magnet Drill

NEW

The HMT MAX200T offers the world's largest capacity for portable drilling, tapping and countersinking. Designed for heavy duty, industrial application, it tackles the most challenging metalworking tasks with its 2850W, high torque, variable speed, reversible motor.

### Technical Specifications

CUTTER SIZE RANGE	12-200mm	WEIGHT	52kg
MAX CUTTER LENGTH	200mm	MAGNET SIZE	295x140x70mm
MAX TWIST DRILL	56mm	MAGNETIC FORCE	2700kg
TAPPING RANGE	M52	POWER CONSUMPTION	2,850W
COUNTERSINKING	110mm	SPEED RPM (No Load)	40-60//90-130//170-240//380-545
REAMING	56mm	SPINDLE	MT5
LENGTH	455mm	ARBOR	31.75mm (1-1/4") Weldon
WIDTH INC HANDLES	280mm	COOLANT SYSTEM	Included
HEIGHT	730-955mm	WARRANTY	1 Year
STROKE	330mm		



803096-110	HMT MAX200T Magnet Drill 110v
803096-230	HMT MAX200T Magnet Drill 230v



MAX150T & MAX200Ts both supplied with a heavy duty, wheeled site case, morse taper broaching arbor, handles, restraint strap, heavy duty metal guard & gravity fed coolant system.

## Longer life, faster cuts Ultimate value for money

CarbideMax TCT Broach cutters by Holemaker Technology are a new generation of broach cutter proven to more than halve the cost of hole broaching compared with traditional HSS cutters.

CarbideMax TCT cutters also offer a life expectancy up to 10x that of standard HSS cutters and cutting speeds up to 64% faster thanks to their individually brazed Tungsten Carbide cutting teeth and elaborate tool geometry.

This specialist construction also results in quieter, easier drilling, with smooth, accurate holes and chatter free performance throughout the cut.

The CarbideMax range - stronger and faster for longer, the ultimate value for money.



### A NEW GENERATION OF LONG-LIFE CUTTER

#### UP TO 10X LONGER LIFE

Tungsten Carbide is one of the hardest materials available for use in cutting tools.

The HMT CarbideMax range uses Premium Grade Sandvik Tungsten Carbide teeth meaning that cutters are capable of drilling the toughest steels whilst maintaining strength & cutting surface for up to 10x longer than traditional HSS cutters.

This leads to greater efficiency and fewer stops as fewer tools are reordered and replaced.

#### UP TO 64% FASTER CUTS

The elaborate geometry of CarbideMax broach cutters means the teeth of the cutter do all the work.

This reduces strain on the tool body and means that a strong but thin flexible alloy can be used for its construction.

Thinner walls means CarbideMax tools need to remove less material from the work piece resulting in a faster cut and quieter, easier drilling.

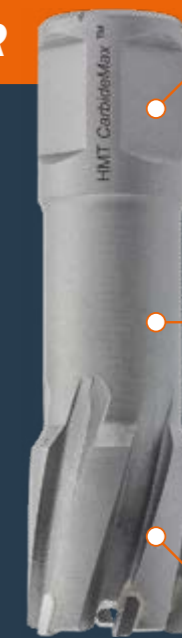

Standard Weldon Shank suitable for all Magnet Drills



Tool body made from flexible steel alloy which results in fewer breakages & faster cut



Highest performance teeth suitable for cutting the hardest steels

Watch the video



#### Sizes available

Standard Sizes				Extreme Drilling Depth		Ultra Large Diameter	
							
Ø 12-80mm	12-60mm	12-50mm	14-60mm	18-50mm	18-50mm	61-150mm	61-200mm
CD 40mm	55mm	80mm	110mm	150mm	200mm	55mm	110mm

CD = Cutting Depth

#### Features & Benefits - The world's largest range of in-stock & available TCT products

- Up to 10x the life of standard HSS cutters
- Up to 64% faster than HSS cutters
- Premium Sandvik Tungsten Carbide teeth
- Fits all standard 19.05mm Weldon shanks
- Works well in Stainless Steel & Cast Iron
- Elaborate tool geometry for a smooth cut
- More than halves the cost of hole broaching
- Reduced thickness tool made from flexible alloy steel results in fewer breakages

## CarbideMax 40 Broach Cutter

## WELDON SHANK

The CarbideMax™ 40 Series will broach up to 35mm thickness of metal. Individually brazed cutting teeth are made from Tungsten Carbide capable of drilling through the toughest steels.

- Up to 10x longer life than traditional HSS Cutters
- 64% Faster cuts than HSS cutters
- Elaborate cutting geometry for faster, quieter drilling
- Chatter free performance

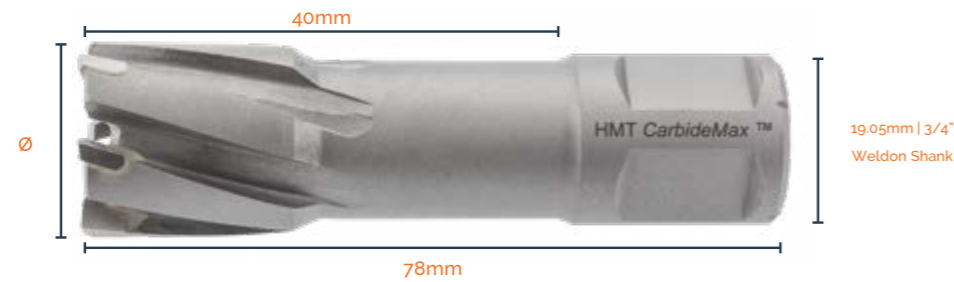

Part No	D Ø mm
108030-0120	12mm
108030-0130	13mm
108030-0140	14mm
108030-0150	15mm
108030-0160	16mm
108030-0170	17mm
108030-0180	18mm
108030-0190	19mm
108030-0200	20mm
108030-0210	21mm
108030-0220	22mm
108030-0230	23mm
108030-0240	24mm
108030-0250	25mm
108030-0260	26mm
108030-0270	27mm
108030-0280	28mm
108030-0290	29mm
108030-0300	30mm
108030-0310	31mm
108030-0320	32mm
108030-0330	33mm
108030-0340	34mm
108030-0350	35mm
108030-0360	36mm
108030-0370	37mm

Part No	D Ø mm
108030-0380	38mm
108030-0390	39mm
108030-0400	40mm
108030-0410	41mm
108030-0420	42mm
108030-0430	43mm
108030-0440	44mm
108030-0450	45mm
108030-0460	46mm
108030-0470	47mm
108030-0480	48mm
108030-0490	49mm
108030-0500	50mm
108030-0550	55mm
108030-0600	60mm
108030-0650	65mm
108030-0700	70mm
108030-0750	75mm
108030-0800	80mm

Pilot Pins			
For 12-17mm cutters			
	ØDia	Length	
108030P-0170	6.34	90	
108030P-0170-P10	6.34	90	
For 18-80mm cutters			
108030P-0600	7.98	90	
108030P-0600-P10	7.98	90	



### NEW InsertFoil Sets

Compatible with the VersaDrive **STAKIT** system

See pages 48 - 53

108030-SET	3 pcs	14, 18, 22mm + 2 Pilot Pins
108030-5SET	5 pcs	12, 14, 18, 22, 26mm + 2 Pilot Pins

## CarbideMax 55 Broach Cutter

## WELDON SHANK

The CarbideMax™ 55 Series will broach up to 50mm thickness of metal. Individually brazed cutting teeth are made from Tungsten Carbide capable of drilling through the toughest steels.

- Up to 10x longer life than traditional HSS Cutters
- 64% Faster cuts than HSS cutters
- Elaborate cutting geometry for faster, quieter drilling
- Chatter free performance

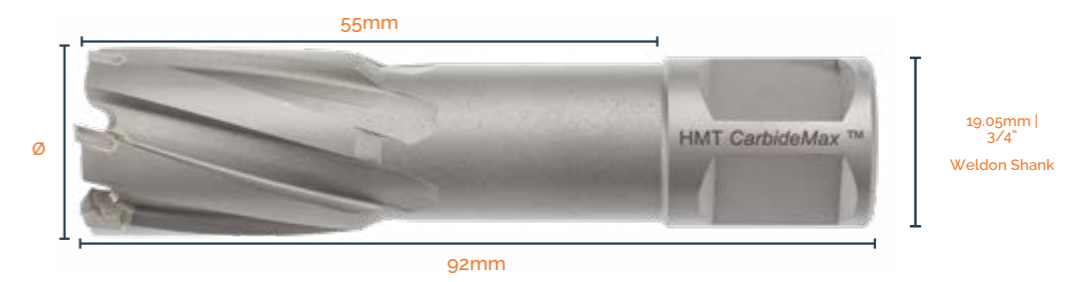

Part No	D Ø mm
108020-0120	12mm
108020-0130	13mm
108020-0140	14mm
108020-0150	15mm
108020-0160	16mm
108020-0170	17mm
108020-0175	17.5mm
108020-0180	18mm
108020-0190	19mm
108020-0200	20mm
108020-0210	21mm
108020-0220	22mm
108020-0230	23mm
108020-0240	24mm
108020-0250	25mm
108020-0260	26mm
108020-0265	26.5mm
108020-0270	27mm
108020-0280	28mm
108020-0290	29mm
108020-0300	30mm
108020-0310	31mm
108020-0320	32mm
108020-0330	33mm
108020-0340	34mm
108020-0350	35mm
108020-0360	36mm
108020-0370	37mm

Part No	D Ø mm
108020-0380	38mm
108020-0390	39mm
108020-0400	40mm
108020-0410	41mm
108020-0420	42mm
108020-0430	43mm
108020-0440	44mm
108020-0450	45mm
108020-0460	46mm
108020-0470	47mm
108020-0480	48mm
108020-0490	49mm
108020-0500	50mm
108020-0510	51mm
108020-0520	52mm
108020-0530	53mm
108020-0540	54mm
108020-0550	55mm
108020-0560	56mm
108020-0570	57mm
108020-0580	58mm
108020-0590	59mm
108020-0600	60mm

Pilot Pins			
For 12-17mm cutters			
	ØDia	Length	Unit of sale
108020P-0170	6.34	103	Pack 2
108020P-0170-P10	6.34	103	Pack 10
For 17.5-60mm cutters			
108020P-0600	7.98	103	Pack 2
108020P-0600-P10	7.98	103	Pack 10

### NEW InsertFoil Sets

Compatible with the VersaDrive **STAKIT** system

See pages 48 - 53

108020-SET	3 pcs	14, 18, 22mm + 2 Pilot Pins
108020-5SET	5 pcs	12, 14, 18, 22, 26mm + 2 Pilot Pins



## CarbideMax 80 Broach Cutter

The CarbideMax™ 80 Series will broach up to 75mm thickness of metal. Individually brazed cutting teeth are made from Tungsten Carbide capable of drilling through the toughest steels.

- Up to 10x longer life than traditional HSS Cutters
- 64% Faster cuts than HSS cutters
- Elaborate cutting geometry for faster, quieter drilling
- Chatter free performance



## WELDON SHANK

## CarbideMax 110 Broach Cutter

The CarbideMax™ 110 Series will broach up to 105mm thickness of metal. Individually brazed cutting teeth are made from Tungsten Carbide capable of drilling through the toughest steels.

- Up to 10x longer life than traditional HSS Cutters
- 64% Faster cuts than HSS cutters
- Elaborate cutting geometry for faster, quieter drilling
- Chatter free performance



## WELDON SHANK



Part No	D Ø mm
108010-0120	12mm
108010-0140	14mm
108010-0160	16mm
108010-0180	18mm
108010-0200	20mm
108010-0220	22mm
108010-0240	24mm
108010-0260	26mm
108010-0280	28mm
108010-0300	30mm
108010-0320	32mm
108010-0330	33mm
108010-0340	34mm
108010-0350	35mm

Part No	D Ø mm
108010-0360	36mm
108010-0380	38mm
108010-0390	39mm
108010-0400	40mm
108010-0420	42mm
108010-0450	45mm
108010-0500	50mm

Pilot Pins - Pack of 2		
For 12-17mm cutters	Dia ø (mm)	Length (mm)
108010P-0170	6.34	130
For 18-60mm cutters	Dia ø (mm)	Length (mm)
108010P-0600	7.98	130



### NEW InsertFoam Set

Compatible with the VersaDrive **STAKIT** system

See pages 48 - 53

108010-SET	5 pcs	12, 14, 18, 22, 26mm + 2 Pilot Pins
------------	-------	-------------------------------------

Part No	D Ø mm
108040-0140	14mm
108040-0160	16mm
108040-0180	18mm
108040-0190	19mm
108040-0200	20mm
108040-0210	21mm
108040-0220	22mm
108040-0230	23mm
108040-0240	24mm
108040-0250	25mm
108040-0260	26mm
108040-0270	27mm
108040-0280	28mm
108040-0290	29mm
108040-0300	30mm
108040-0320	32mm
108040-0330	33mm
108040-0340	34mm
108040-0350	35mm
108040-0360	36mm
108040-0380	38mm
108040-0390	39mm
108040-0400	40mm
108040-0410	41mm
108040-0420	42mm

Part No	D Ø mm
108040-0430	43mm
108040-0440	44mm
108040-0450	45mm
108040-0460	46mm
108040-0470	47mm
108040-0480	48mm
108040-0490	49mm
108040-0500	50mm
108040-0510	51mm
108040-0520	52mm
108040-0540	54mm
108040-0550	55mm
108040-0560	56mm
108040-0570	57mm
108040-0580	58mm
108040-0590	59mm
108040-0600	60mm

Pilot Pins - Pack of 2		
For 14-17mm cutters	Dia ø (mm)	Length (mm)
108040P-0171	6.34	155
For 18-60mm cutters	Dia ø (mm)	Length (mm)
108040P-0600	7.98	155

### NEW InsertFoam Set

See pages 48 - 53

### Extreme drilling depth with CarbideMax Extra Long.

For the most extreme drilling depths the CarbideMax range offers 150mm & 200mm extra long broach cutters.

With precision drilling flutes and a specially engineered geometry for accurate cutting these cutters come with a standard 19.05mm Weldon shank for use in any Magnet Drill with sufficient stroke.

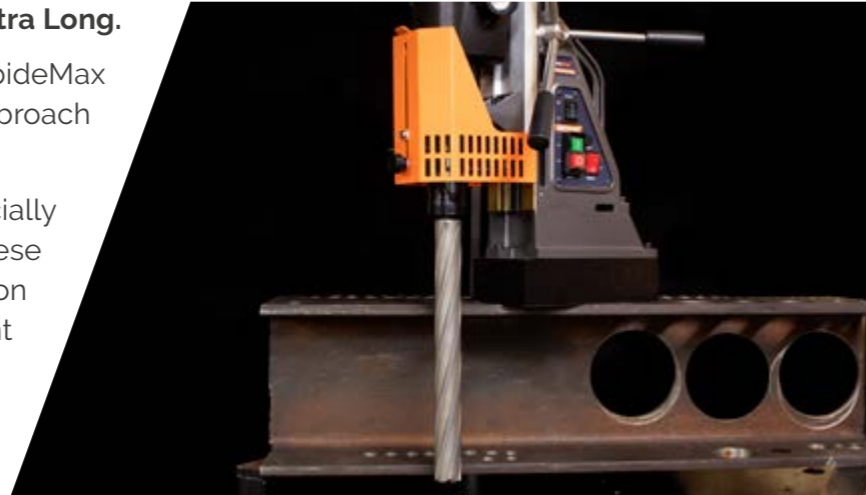

### Drill matching holes through box or H section in a single pass

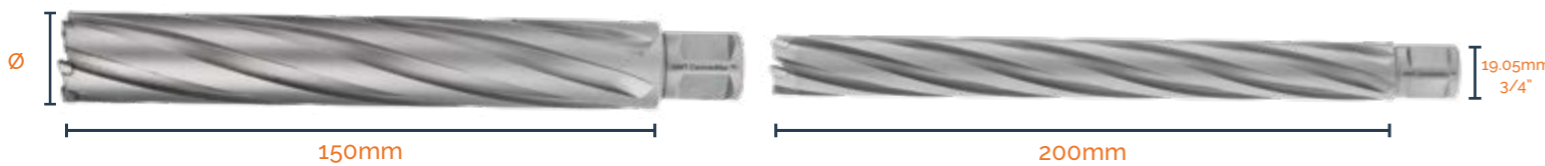

150mm Cutting Depth	D Ø mm
108045-0180	18mm
108045-0200	20mm
108045-0220	22mm
108045-0240	24mm
108045-0260	26mm
108045-0280	28mm
108045-0300	30mm
108045-0320	32mm
108045-0330	33mm
108045-0360	36mm
108045-0390	39mm
108045-0500	50mm

200mm Cutting Depth	D Ø mm
108050-0180	18mm
108050-0200	20mm
108050-0220	22mm
108050-0240	24mm
108050-0260	26mm
108050-0300	30mm
108050-0320	32mm
108050-0330	33mm
108050-0360	36mm
108050-0390	39mm
108050-0420	42mm
108050-0450	45mm
108050-0500	50mm

### Pilot Pins

For 150mm Cutting Depth	Dia Ø	Length	Unit of sale
108045P-0600	7.98	205	Pack 2

For 200mm Cutting Depth	Dia Ø	Length	Unit of sale
108050P-0600-2P	7.98	255	Pack 2

When using the 2 part pilot pin and drilling material greater than 50mm thick, when the pilot pin reaches the extent to which it can retract inside the Magnet Drill arbor, the bottom section of the pilot can be removed to allow the hole to be completed without removing the pilot pin from the cutter.

### Ultra large diameter drilling with CarbideMax XL.

With the requirement for ultra large diameter broaching fast increasing, the CarbideMax-XL™ range offers cutters from 61mm up to 200mm diameter with a 55mm or 110mm cutting depth.

These high quality TCT cutters have a reinforced 31.75mm diameter shank to withstand the high levels of torque generated.

Adapters are available to convert the 31.75mm shank for use with standard 19.05mm weldon shank Magnet Drills.



55mm Cutting Depth	D Ø mm
108020-0610	61mm
108020-0620	62mm
108020-0630	63mm
108020-0640	64mm
108020-0650	65mm
108020-0660	66mm
108020-0670	67mm
108020-0680	68mm
108020-0690	69mm
108020-0700	70mm
108020-0750	75mm
108020-0800	80mm
108020-0850	85mm
108020-0900	90mm

55mm Cutting Depth	D Ø mm
108020-0950	95mm
108020-1000	100mm
108020-1050	105mm
108020-1100	110mm
108020-1150	115mm
108020-1200	120mm
108020-1250	125mm
108020-1300	130mm
108020-1350	135mm
108020-1400	140mm
108020-1450	145mm
108020-1500	150mm

110mm Cutting Depth	D Ø mm
108040-0610	61mm
108040-0620	62mm
108040-0630	63mm
108040-0640	64mm
108040-0650	65mm
108040-0660	66mm
108040-0670	67mm
108040-0680	68mm
108040-0690	69mm
108040-0700	70mm
108040-0730	73mm
108040-0750	75mm
108040-0800	80mm
108040-0850	85mm
108040-0900	90mm
108040-0950	95mm

110mm Cutting Depth	D Ø mm
108040-1000	100mm
108040-1050	105mm
108040-1100	110mm
108040-1150	115mm
108040-1200	120mm
108040-1250	125mm
108040-1300	130mm
108040-1350	135mm
108040-1400	140mm
108040-1500	150mm
108040-1600	160mm
108040-1700	170mm
108040-1800	180mm
108040-1900	190mm
108040-2000	200mm

### 31.75mm to 19.05mm Weldon Shank Adapter & Pilot

Adapts 31.75mm shank cutters to 19.05mm standard Magnet Drill fitting; includes pilot



Part No	Details
103091-1932-55	19.05 Male to 31.75mm Female Weldon Adapter + Pilot for 55mm cutters
103091-1932-110	19.05 Male to 31.75mm Female Weldon Adapter + Pilot for 110mm cutters

### 31.75mm Weldon Shank Morse Taper Arbor & Pilot (Spring loaded for cutter slug ejection)



Part No	Arbor Size	Shank Size
103013-0323	MT3	31.75mm / 1 1/4"
103013-0324	MT4	31.75mm / 1 1/4"
108020P-1500	CarbideMax55 Pilot Pin, 61-150mm, Pk 2	
108040P-1500-2P	CarbideMax110 2 Piece Pilot Pin 61-200mm, Pk2	

## CarbideMax RAIL Broach Cutters

The railways keep the country moving and regular maintenance & repair work is necessary to keep them in excellent condition.

As a Network Rail Approved supplier, HMT has developed a range of broach cutters specifically designed to speed up and reduce the costs of drilling rail track material.

Specially machined cutting geometries offer superior performance against HSS cutters and other similar alternatives with in excess of 100 holes in UIC 60 Rail achievable.

CarbideMax Rail Cutters are suitable for Cembre, Rotabroach and other similar rail track drilling machines.

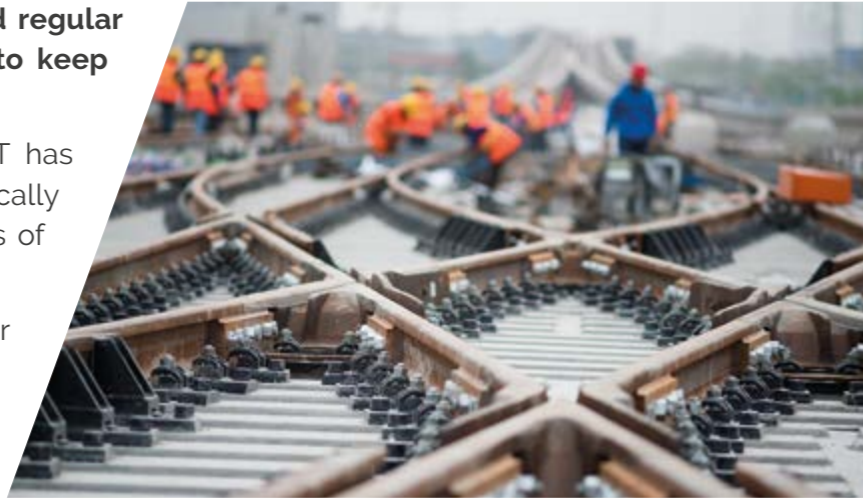

## WELDON SHANK

## Weldon Shank Twist Drill Bits

## WELDON SHANK

HSS-XE twist drill bits with integrated Weldon shank for simple and accurate drilling in steel and fast tool changing. Removes the need for using a separate drill chuck in a Magnet Drill.

Where drilling smaller holes or tapping size holes has been a long and time consuming job in the past, fitting the SilverMax Weldon Shank Twist Drills into a Magnet Drill can suddenly make the job far quicker and safer than struggling with a Pistol Drill and jobber drills.



### FEATURES & BENEFITS

- Integrated weldon shank
- Simple & accurate drilling in steel
- No need for a tool chuck when using a Magnet Drill
- Fast tool changing
- Quicker and safer than struggling with a Pistol Drill
- Fits 19.05mm arbors - use with any standard mag drill

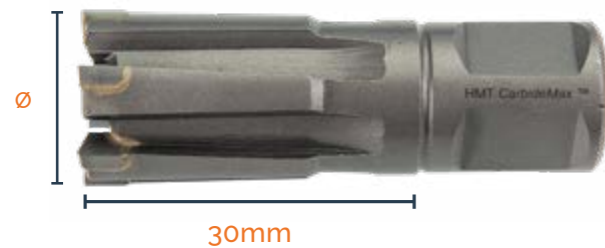

30mm Cutting Depth	D Ø mm
106030-0180	18mm
106030-0200	20mm
106030-0220	22mm
106030-0240	24mm
106030-0260	26mm
106030-0280	28mm
106030-0300	30mm
106030-0320	32mm
106030-0330	33mm
106030-0360	36mm

55mm Cutting Depth	D Ø mm
106020-0180	18mm
106020-0200	20mm
106020-0220	22mm
106020-0240	24mm
106020-0260	26mm
106020-0280	28mm
106020-0300	30mm
106020-0320	32mm
106020-0330	33mm
106020-0360	36mm

Part No	Diameter mm	Shank Size	Tap Size (Metric Coarse)
201070-0050	5.0mm	19.05mm / 3/4"	M6
201070-0060	6.0mm	19.05mm / 3/4"	-
201070-0068	6.8mm	19.05mm / 3/4"	M8
201070-0070	7.0mm	19.05mm / 3/4"	-
201070-0080	8.0mm	19.05mm / 3/4"	-
201070-0085	8.5mm	19.05mm / 3/4"	M10
201070-0090	9.0mm	19.05mm / 3/4"	-
201070-0100	10.0mm	19.05mm / 3/4"	-
201070-0102	10.2mm	19.05mm / 3/4"	M12
201070-0110	11.0mm	19.05mm / 3/4"	-
201070-0120	12.0mm	19.05mm / 3/4"	-

### Pilot Pins

For 30mm Cutting Depth	Dia Ø	Length	Unit of sale
106030P-0360	7.98	77	Pack 2
For 55mm Cutting Depth			
108020P-0600	7.98	103	Pack 2

### NEW InsertFoil Sets

Compatible with the VersaDrive STAKIT system

See pages 48 - 53

201070-SET	4 pcs	6, 8, 10, 12mm
201070-TSET	4 pcs	5, 6.8, 8.5, 10.2mm



# Countersinks

HMT Weldon Shank TCT Countersink - 90°



Premium countersink with 3X heavy duty tungsten carbide inserts for maximum life in challenging materials. Standard 19.05mm Weldon shank for use in all standard Magnet Drills. Use with a 103013 Morse taper arbor to use in a Pillar Drill or Radial Drill.

Part No	Size
601035-0320	32mm TCT 90° Countersink

HMT 90° Carbide Indexable Countersink 76mm



76mm heavy-duty large countersink with Morse Taper shank. Each countersink is supplied with Premium replaceable carbide inserts for cost effective performance in structural metals. Supplied with set of 3 tips which are double sided for extended use.

Part No	Product
602040-0760	MT3 Carbide Indexable Countersink
602040-0760R	Single Tungsten Carbide Tip - 2 sided

# WELDON SHANK

GoldMax HSS Weldon Countersink - 90°



Specially coated for increased tool life.

Standard 19.05mm Weldon shank for use in all standard Magnet Drills.

Part No	Size
601025-0300	30mm
601025-0400	40mm
601025-0550	55mm

HMT Magnet Drill Countersink - 50mm, 60°



High Speed Steel material with precision ground flutes. Standard 19.05mm Weldon shank for use in all standard Magnet Drills.

Part No	Size
601040-0500	50mm

# VersaDrive MultiSink® System

The MultiSink is a worldwide unique new Combination Countersink Tool designed and developed by HMT for use with Magnetic Drills.

The tool is designed to combine with the VersaDrive product range to Broach & Countersink, Drill & Countersink, Tap & Countersink or even Drill, Tap & Countersink in one operation - providing huge time-saving benefits.



19.05mm | 3/4"  
Weldon Shank

## FEATURES & BENEFITS

- Innovative combination countersinking tool
- Save time completing countersunk holes
- Broach/Drill & countersink in one operation
- Tap & countersink in one operation

## QUICK GUIDE

- Tapping operations require a Mag Drill with variable speed & reverse
- For pre-drilled holes, always use with a pilot to avoid damage
- When used for multiple operations, e.g. tapping then countersinking, it is important to use the correct RPM for each operation
- 82° and ULTRA coated versions also available



## CarbideMax TCT MultiSink®

Part No	D Ø mm	Ø d2 mm	L	Countersink Angle
601055-0400	40mm	14mm	100mm	90°
601055-0550	55mm	14mm	109mm	90°

## MultiSink® Ejector Pilot Pin

For use with VersaDrive HoleCutters



Part No	d1 Ø	l1 mm	Unit of sale
101030P-0003	6.35	145	Pack 2

Watch the video  
YouTube



## MultiSink® Pilot

For countersinking bolt holes from 16 - 26mm diameter. Use MultiSink with variable speed Magnet Drill. The speed must be reduced when countersinking.

Part No	d1 Ø	Shank mm
601050-0160	16mm	11.0
601050-0180	18mm	11.0
601050-0200	20mm	11.0
601050-0220	22mm	11.0
601050-0240	24mm	11.0
601050-0260	26mm	11.0



52mm



# CARBIDEMAX<sup>®</sup> ULTRA

TUNGSTEN CARBIDE TECHNOLOGY

Premium, long-life tooling  
for use in the most challenging applications

HMT have developed a generation of ULTRA cutting tools for use in the most challenging applications.

The specialist ULTRA coating is proven to significantly increase tool life, making ULTRA products the perfect solution in situations requiring high performance durability, prolonged use or machining extremely hard materials.

They are produced from premium grade materials and coated using a range of state of the art, high-temperature surface coatings.



Capable of providing a service life up to  
**10x longer than uncoated TCT tools.**

## THE RANGE

Watch the video



ULTRA Twist Drills  
209020

ULTRA TCT Broach Cutters  
108070 & 108090

ULTRA Straight Flute Cutters  
106025 & 106035

ULTRA 90° Countersink 32mm  
601036

ULTRA Coated Multisink  
601056

## MACHINING WEAR PLATE

The extreme hardness and resistance of wear plate makes machining it extremely challenging. Good results are dependent on the right setup - including high torque/slow speed, geared Magnet Drills, like the VersaDrive Series, and ample lubrication - BioCut Blue cutting fluid when broaching or Speedlube Aerosol spray when countersinking.

Using an incorrect or poorly maintained Magnet Drill with unstable drilling operation, poor magnet hold, excessive pressure or inadequate lubrication is likely to result in rapid tool failure.

Even with high tech tooling, successfully machining Wear plates is challenging with little or no margin for error. It not only requires the correct setup but also experienced operators with the time necessary to proceed with caution.

### Features & Benefits

-  Use for increased durability
-  Cuts material 5x harder than S275 Structural Steel
-  Use on wear plate & armour plate
-  Use on Stainless Steel
-  Perfect for use on heavy equipment & machinery
-  Use with Biocut Blue & SpeedLube lubricants

Ideal for use on **HARDOX - CREUSABRO - ABRO - RAEX - STRENX - BISALLOY**

## ULTRA Broach Cutters

CarbideMax Ultra cutters are specifically designed for long-life performance in the toughest broaching jobs on the planet, including Hardox steel.

- Individually brazed, highest quality carbide cutting teeth
- ULTRA coated for optimum performance & lifespan
- Elaborate cutting geometry for faster, quieter drilling
- Chatter free performance when used correctly

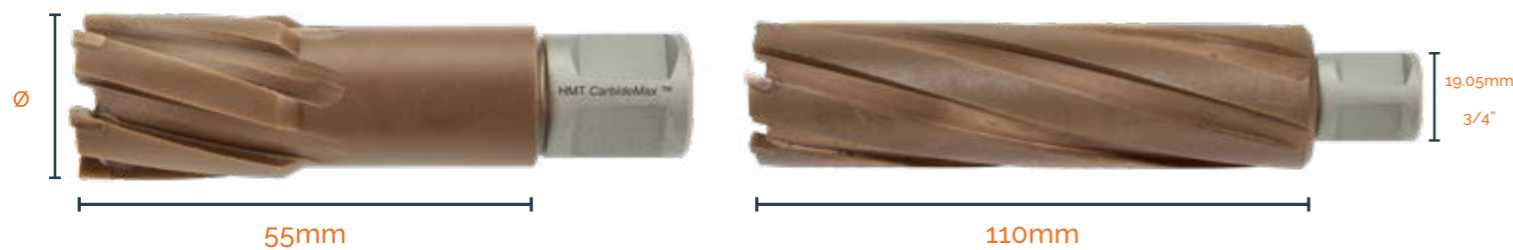

55mm Cutting Depth	D Ø mm	55mm Cutting Depth	D Ø mm	110mm Cutting Depth	D Ø mm	110mm Cutting Depth	D Ø mm
108070-0160	16mm	108070-0380	38mm	108090-0160	16mm	108090-0400	40mm
108070-0170	17mm	108070-0390	39mm	108090-0180	18mm	108090-0410	41mm
108070-0175	17.5mm	108070-0400	40mm	108090-0190	19mm	108090-0420	42mm
108070-0180	18mm	108070-0410	41mm	108090-0200	20mm	108090-0430	43mm
108070-0190	19mm	108070-0420	42mm	108090-0210	21mm	108090-0440	44mm
108070-0200	20mm	108070-0430	43mm	108090-0220	22mm	108090-0450	45mm
108070-0210	21mm	108070-0440	44mm	108090-0230	23mm	108090-0460	46mm
108070-0220	22mm	108070-0450	45mm	108090-0240	24mm	108090-0470	47mm
108070-0230	23mm	108070-0460	46mm	108090-0250	25mm	108090-0480	48mm
108070-0240	24mm	108070-0470	47mm	108090-0260	26mm	108090-0490	49mm
108070-0250	25mm	108070-0480	48mm	108090-0270	27mm	108090-0500	50mm
108070-0260	26mm	108070-0490	49mm	108090-0280	28mm	108090-0510	51mm
108070-0265	26.5mm	108070-0500	50mm	108090-0290	29mm	108090-0520	52mm
108070-0270	27mm	108070-0510	51mm	108090-0300	30mm	108090-0540	54mm
108070-0280	28mm	108070-0520	52mm	108090-0320	32mm	108090-0550	55mm
108070-0290	29mm	108070-0530	53mm	108090-0330	33mm	108090-0560	56mm
108070-0300	30mm	108070-0540	54mm	108090-0340	34mm	108090-0570	57mm
108070-0310	31mm	108070-0550	55mm	108090-0350	35mm	108090-0580	58mm
108070-0320	32mm	108070-0560	56mm	108090-0360	36mm	108090-0590	59mm
108070-0330	33mm	108070-0570	57mm	108090-0380	38mm	108090-0600	60mm
108070-0340	34mm	108070-0580	58mm	108090-0390	39mm		
108070-0350	35mm	108070-0590	59mm				
108070-0360	36mm	108070-0600	60mm				
108070-0370	37mm						

### Pilot Pins

55mm Cutting Depth	For 12-17mm cutters	Dia Ø	Length	Qty
	108020P-0170	6.34	103	Pack 2
110mm Cutting Depth	For 18-60mm cutters	Dia Ø	Length	Qty
	108020P-0600	7.98	103	Pack 2

55mm Cutting Depth	For 14-17mm cutters	Dia Ø	Length	Qty
	108040P-0171	6.34	155	Pack 2
110mm Cutting Depth	For 18-60mm cutters	Dia Ø	Length	Qty
	108040P-0600	7.98	155	Pack 2

### NEW InsertFoil Sets

Compatible with the VersaDrive **STAKIT** system

See pages 48 - 53



## WELDON SHANK

## ULTRA MultiSink & Countersink

## WELDON SHANK

The Ultra coated Multisink and Weldon Countersink offer increased wear resistance and long-life performance whilst countersinking the most challenging applications, including materials like Hardox, Inconel and Armor plate.

The MultiSink is a worldwide unique new Combination Countersink Tool designed & developed by HMT for use with Magnetic Drills.



### FEATURES & BENEFITS

- Innovative combination countersinking tool
- Save time completing countersunk holes
- Suitable for holes 16mm and above

### QUICK GUIDE

- For pre-drilled holes, always use with a pilot to avoid damage
- When used for multiple operations, e.g. drilling then countersinking, it is important to use the correct RPM for each operation

Part No	D Ø mm	Point Angle	Shank mm
601056-0400	40mm	90°	19.05mm / 3/4"
601056-0550	55mm	90°	19.05mm / 3/4"
MultiSink Pilots			
Part No	D Ø mm	Length (mm)	Shank (mm)
601050-0160	16mm	52	11.0
601050-0180	18mm	52	11.0
601050-0200	20mm	52	11.0
601050-0220	22mm	52	11.0
601050-0240	24mm	52	11.0
601050-0260	26mm	52	11.0

Use Multisink pilot when countersinking bolt holes from 16 - 26mm diameter. Use Multisink with variable speed Magnet Drill. The speed must be reduced when countersinking.

## ULTRA Weldon Countersink

Premium, ULTRA coated countersink with 3X heavy duty tungsten carbide inserts for maximum life in challenging materials. Standard 19.05mm Weldon shank for use in all standard Magnet Drills. Use with a 103013 Morse taper arbor to use in a Pillar Drill or Radial Drill. For use on materials like Hardox & other wear plate.



Part No	Size
601036-0320	32mm ULTRA Countersink 90°

## ULTRA Coated Twist Drill Bits

NEW

VersaDrive Ultra Drill Bits - for Hardox, Wear Plate, and Armour Plate applications.

The new VersaDrive Ultra Drill bits are designed for the toughest applications in the mining, quarrying, and military engineering market.

High grade tool steel combined with the specialist high-performance Ultra coating provides the ability to drill the toughest materials.

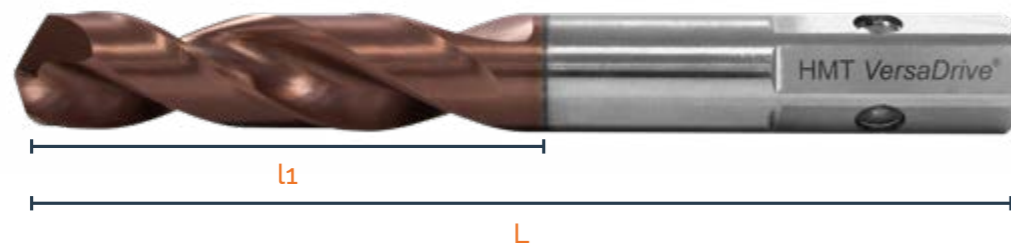

Part No	Diameter (mm)	l1 (mm)	L (mm)
209020-0060	6	28	66
209020-0080	8	37	79
209020-0100	10	43	89
209020-0120	12	51	102
209020-0140	14	54	107

### NEW InsertFam Sets

Compatible with the VersaDrive **STAKIT** system

See pages 48 - 53



209020-SET1	5 pcs	6, 8, 10, 12, 14mm
-------------	-------	--------------------

## VersaDrive SHANK

## ULTRA Straight-Flute Cutters

NEW

Straight flutes and specialist cutting geometries mean that ULTRA Straight-Flute cutters offer superior performance in hard materials like Hardox, Armour plate and Stainless Steel.

Their ULTRA coating helps reduce friction and increase life span when tackling the most challenging broaching jobs and individually brazed Tungsten Carbide teeth give a clean, accurate cut that outperforms the closest comparable products.

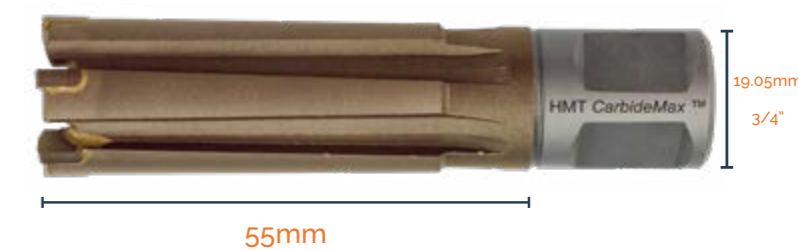
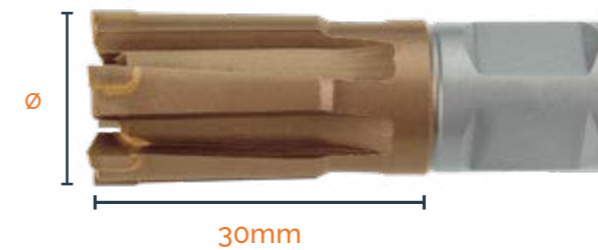
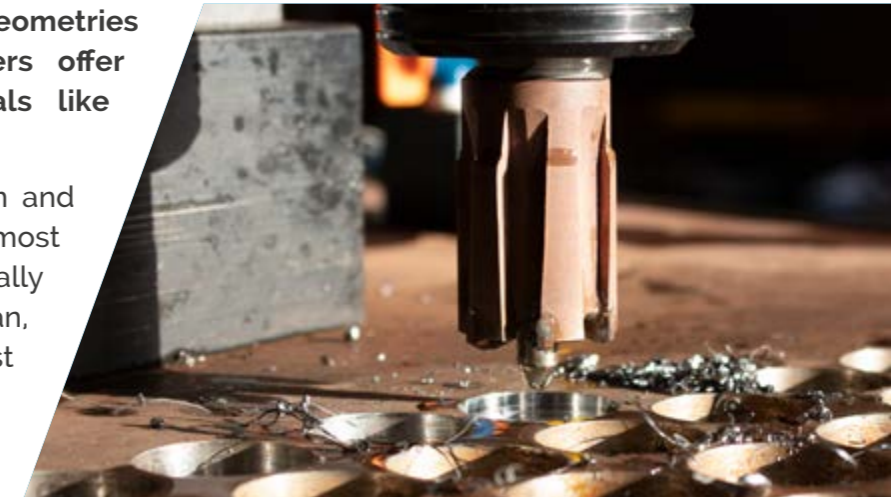

30mm Cutting Depth	D Ø mm
106035-0180	18mm
106035-0200	20mm
106035-0220	22mm
106035-0240	24mm
106035-0260	26mm
106035-0280	28mm
106035-0300	30mm
106035-0320	32mm
106035-0330	33mm
106035-0360	36mm

55mm Cutting Depth	D Ø mm
106025-0180	18mm
106025-0200	20mm
106025-0220	22mm
106025-0240	24mm
106025-0260	26mm
106025-0280	28mm
106025-0300	30mm
106025-0320	32mm
106025-0330	33mm
106025-0360	36mm

### Pilot Pins



For 30mm Cutting Depth	Dia Ø	Length	Unit of sale
106030P-0360	7.98	77	Pack 2
For 55mm Cutting Depth			
108020P-0600	7.98	103	Pack 2

## Weldon Shank - Morse Taper Arbor 19.05mm



Spring loaded for cutter slug ejection

Part No	Arbor Size	Shank Size
103013-0192	MT2	19.05mm / 3/4"
103013-0193	MT3	19.05mm / 3/4"
103013-0194	MT4	19.05mm / 3/4"
103014-0192	MT2 Internal Cooling Arbor 19.05mm	
103014-0193	MT3 Internal Cooling Arbor 19.05mm	

## Spring Loaded Extension Arbor



Spring Loaded extension arbor for very deep drilling using multiple extension arbors in series. The spring loaded design means only the bottom extension needs to be piloted, with standard cutter pilot pin. Will pass through hole diameters greater than 35mm.

Part No	Extension Length	Shank Size
103095-1000	100mm	19.05mm / 3/4"

## 31.75mm to 19.05mm Weldon Shank Adapter & Pilot



Adapts 31.75mm Shank XL cutters to 19.05mm standard Magnet Drill fitting; includes pilot

Part No	Details
103091-1932-55	19.05 Male to 31.75mm Female Weldon Adapter + Pilot for 55mm cutters
103091-1932-110	19.05 Male to 31.75mm Female Weldon Adapter + Pilot for 110mm cutters

## Standard Weldon Shank Extension Arbor



Will pass through hole diameters greater than 35mm

Part No	Extension Length	Shank Size
103090-0500	50mm	19.05mm / 3/4"
103090-0750	75mm	19.05mm / 3/4"
103090-1000	100mm	19.05mm / 3/4"

## Replacement Grub Screws



Part No	Thread Size	Hex Key Size	Unit of sale
103060-0606	M6 x 6	3mm	Pack 10
103060-0808	M8 x 8	4mm	Pack 10
103060-1010	M10 x 10	5mm	Pack 10
103060-1212	M12 x 12	6mm	Pack 10

## 31.75mm Weldon Shank Morse Taper Arbor & Pilot



Spring loaded for cutter slug ejection

Part No	Arbor Size	Shank Size
103013-0323	MT3	31.75mm / 1 1/4"
103013-0324	MT4	31.75mm / 1 1/4"

## Morse Taper Sleeve



Morse Taper sleeve reducers have a smaller internal taper size than the machine (drive) end, to allow a smaller morse taper to be fitted. Hardened and ground high precision specification.

Part No	Size
103615-R21	MT2 outside, MT1 Inside
103615-R32	MT3 outside, MT2 Inside
103615-R43	MT4 outside, MT3 Inside
103615-R53	MT5 outside, MT3 Inside
103615-R54	MT5 outside, MT4 Inside

## Morse Taper Drifts



Tapered steel drifts for simple removal of Morse Taper arbors, drill bits and tooling from MT2, MT3 or MT4 machine spindles

Part No	Suits
103012-0002	MT1 & MT2
103012-0003	MT3
103012-0004	MT4

## Magnetic Swarf Lifter



Part No	Total Length	Magnet Length
103011-0001	400mm	180mm

## Morse Taper Extension



Morse Taper Extensions have an Internal and an External Morse Taper and are used to extend the reach of Magnet Drill Arbors and enable the use of tooling with different size shanks. Hardened and ground high precision specification.

Part No	Size
103616-E32	MT3 outside, MT2 inside
103616-E33	MT3 outside, MT3 inside
103616-E34	MT3 outside, MT4 inside
103616E-E43	MT4 outside, MT3 inside
103616-E44	MT4 outside, MT4 inside

## Heavy Duty Magnet Drill Chuck & Adapter

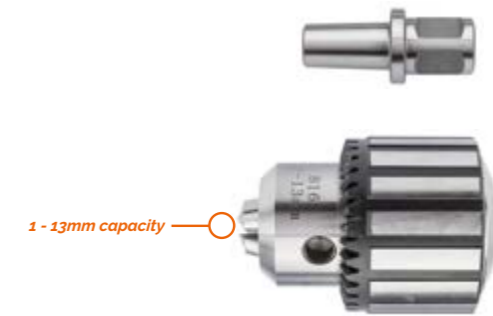

Part No	Description	Fitting Type
103017	Chuck Adapter	19.05mm / 3/4"
103070	Keyed Chuck	1/2" Chuck - B16 taper

## Weldon Quick Change Morse Taper Magnet Drill Arbor



Weldon Morse Taper Arbor with a smooth action, rotating collar and push-release action to allow rapid tool or adapter loading and unloading without the need for fiddly, time consuming grub screws or Allen keys. Takes 19.05mm (3/4") Magnet Drill Weldon fitting.

Part No	Description
103016-0192	MT2 Quick change arbor
103016-0193	MT3 Quick change arbor

## GoldMax Tungsten Carbide Burrs

### GoldMax TCT Burr - Flame



Standard 6mm Shank

Part No	Head Dimension	Total Length
402050-0060	6 x 16mm	60mm
402050-0120	12 x 25mm	70mm

### GoldMax TCT Burr - Ball Nose



Standard 6mm Shank

Part No	Head Dimension	Total Length
402020-0060	6 x 16mm	60mm
402020-0120	12 x 25mm	69mm

### GoldMax TCT Burr - Tree



Standard 6mm Shank

Part No	Head Dimension	Total Length
402060-0060	6 x 16mm	60mm
402060-0120	12 x 25mm	69mm

### GoldMax TCT Burr - Cylinder End Cut



Standard 6mm Shank

Part No	Head Dimension	Total Length
402040-0060	6 x 16mm	60mm
402040-0120	12 x 25mm	69mm

### GoldMax TCT Burr - Ball



Standard 6mm Shank

Part No	Head Dimension	Total Length
402010-0060	6 x 6mm	50mm
402010-0120	12 x 10mm	55mm

### GoldMax TCT Burr - 4 Piece Set



4 Piece set contains Flame, Cylinder, Ball Nose and Tree Burrs in 6 or 12mm head diameter

Part No	Head Dimension
4020-SET2	6mm
4020-SET1	12mm

## Metal Cutting Lubricants

### SpeedLube™ Lubricant Spray



SpeedLube™ is a high performance foaming lubricant suitable for a wide variety of metal drilling applications across a range of materials including stainless steel.

Aerosol propellant ensures the lubricant foams on contact to ensure maximum tool coverage and heat dissipation. Easy one-handed application provides fast, efficient lubricant coverage and minimises the amount of applications needed during the drilling process. Unique 360° valve which enables Speedlube to be sprayed from all angles.

Part No	Aerosol Size	Unit of Sale
701010-0002	500ml	Each
701010-0002-P12	500ml	Pack of 12

### AeroPaste™ Lubricant Spray



AeroPaste™ is an aerosol applied paste-type, metalworking lubricant for hole broaching, tapping, reaming & drilling applications. Ideal for overhead or positional application, the high viscosity of AeroPaste allows it to cling directly to the cutting tool or steel it is applied to, without fluid run-off.

Ideal for use in environmentally sensitive areas such as above water. Using AeroPaste minimises repainting or galvanising issues caused by conventional soluble lubricants and reduces mess and slipping hazards.

Part No	Aerosol Size	Unit of Sale
701010-0001	500ml	Each
701010-0001-P12	500ml	Pack of 12

### BioCut Blue Neat Broaching Oil



BioCut Blue is a ultra high-performance cutting fluid designed for metal fabrication broaching, cutting, and drilling tasks.

- Water-soluble fluid supplied ready-for-use.
- Inherently bio-degradable, can be 100% removed with water.
- Synthetic based, chlorine free, with zero mineral oils.
- No adverse affects for welding and galvanising.
- Excellent performance on Stainless Steel & Hardox type materials

Part No	Bottle Size	Unit of Sale
704010-0001	5 Litres	Each
704010-0001-P4	5 Litres	Box of 4
704010-0002	500ml Bottle	Each
704010-0002-P20	500ml Bottle	Box of 20

### BioCut Paste - Drilling & Tapping Paste

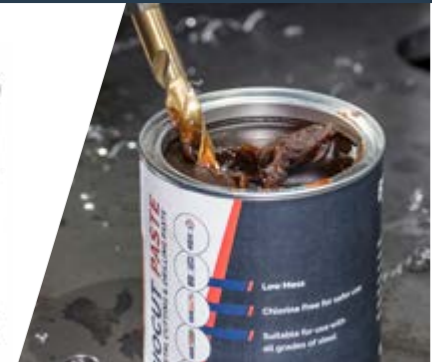

BioCut Drilling & Cutting paste is specifically formulated for superb performance when used with HMT Impact Wrench cutting tools. Extreme pressure concentration provides accurate hole lubrication. Excellent general purpose paste lubricant when drilling, tapping, countersinking, reaming and broaching. Chlorine Free for safer use. Suitable for use with all grades of steel including Stainless Steel & Aluminium.

Part No	Aerosol Size	Unit of Sale
704030-0001	250g	Each
704030-0001-P16	250g	Pack of 16



Revolutions per minute- RPM (Rotary)

Diameter	Structural Steel <500 Mpa (S275, S355) Based on mm/R Feed of 0.10	Structural Steel <1000 Mpa Based on mm/R Feed of 0.10	Stainless Steel INOX Based on mm/R Feed of 0.13	Cast Iron-Grey	Aluminium
	RPM Range				
12-19 mm	1265-850	850-580	530-350	925-615	2200-1560
20-25 mm	840-650	550-410	345-255	610-440	1480-1140
26-32 mm	545-460	410-315	250-200	430-335	1125-890
33-39 mm	460-395	315-265	195-170	330-280	885-730
40-46 mm	405-340	265-250	165-140	280-235	720-620
47-53 mm	335-300	250-195	135-120	235-205	615-545
54-60 mm	295-265	195-180	120-105	200-180	540-475
61-70 mm	260-230	180-140	105-90	180-160	475-415
71-80 mm	230-200	140-130	90-70	160-145	410-365
81-90 mm	195-180	130-115	70-65	140-125	350-325
91-100 mm	180-160	115-100	60-55	125-110	320-280
101-112 mm	160-140	100-90	55-50	110-100	280-250
113-124 mm	140-120	90-85	50-48	100-90	250-235
125-136 mm	120-110	85-75	48-45	90-80	230-205
137-150 mm	110-100	70-65	45-40	80-75	205-190
151 - 174mm	70 - 80	50 - 60	45 - 40	55 - 65	145 - 155
175 - 200mm	60 - 70	40 - 50	25 - 30	45 - 55	120 - 140



Revolutions per minute- RPM (Rotary)

Diameter	Structural Steel <500 Mpa Based on mm/R Feed of 0.10	Structural Steel <1000 Mpa Based on mm/R Feed of 0.10	Stainless Steel INOX Based on mm/R Feed of 0.13	Aluminium	Cast Iron (Grey)	Fibreglass	Composite	Plastics	Wood
	RPM Range								
13-17MM	1350-850	840-585	500-360	2210-1575	900-625	780-705	1350-850	900-640	1495-1010
18-25MM	850-625	580-420	350-250	1575-1125	600-455	700-520	850-625	620-450	990-895
26-31MM	620-500	415-325	240-195	1080-885	435-345	500-405	620-500	440-345	895-850
32-39MM	480-410	320-275	195-160	875-740	330-285	400-330	480-410	345-280	850-740
40-46MM	390-340	270-220	160-145	730-620	285-240	315-275	390-340	175-235	740-610
47-53MM	335-300	220-180	140-120	615-545	235-215	275-245	335-300	235-215	600-505
54-60MM	295-260	180-165	115-100	525-485	210-180	240-215	295-260	210-185	500-460
61-70MM	260-225	165-155	100-90	475-415	180-160	205-185	260-225	180-160	455-400
71-80MM	220-195	155-140	90-75	410-365	155-140	180-160	220-195	155-140	395-360

## BEST PRACTICE ADVICE

GUIDELINE PARAMETERS ONLY - Actual parameters may vary depending on operating conditions

1. Centre punch or pilot drill the surface for accurate hole start
2. Follow guidelines to set correct RPM speed. Incorrect RPM can lead to poor life or tool breakage
3. Apply firm, steady feed pressure throughout the cut, applying the feed very slowly and cautiously during the first 1mm of cut
4. Avoid lateral movement or tilting which can cause damage to the cutter
5. Ensure regular application of quality cooling lubricant, especially when drilling thick or hardened materials
6. Hardened or heat-affected materials may require higher torque, reduced RPM and feed rates and extra coolant
7. Regularly check that Magnet Drill slides, handles, arbors and movable parts have not vibrated loose over time
8. Ensure a debris free surface of sufficient steel thickness for strong magnet hold when Magnet Drilling
9. For drilling holes in steel thicker than 25mm it is recommended to ventilate the hole frequently to clear the swarf
10. Selecting the correct machine will often result in better life from the consumables and a quicker completion of the task

## QUICK GUIDE

- Adjust RPM to match the material
- Slowly and cautiously begin cutting before increasing pressure
- For best results & swarf clearance always select a cutter longer than the material thickness
- For hard materials & wear plates like Hardox use Ultra coated cutters. See page 80 & 83

## DOWNLOAD



## BEST PRACTICE ADVICE

GUIDELINE PARAMETERS ONLY - Actual parameters may vary depending on operating conditions

1. Centre punch or pilot drill the surface for accurate hole start
2. Follow guidelines to set correct RPM speed. Incorrect RPM can lead to poor life or tool breakage
3. Apply firm, steady feed pressure throughout the cut, applying the feed very slowly and cautiously during the first 1mm of cut
4. Avoid lateral movement or tilting which can cause damage to the tool
5. Ensure regular application of quality cooling lubricant, especially when drilling thick or hardened materials
6. Hardened or heat-affected materials may require higher torque, reduced RPM and feed rates and extra coolant
7. When using a Magnet Drill regularly check that slides, handles, arbors and movable parts have not vibrated loose over time
8. Ensure a debris free surface of sufficient steel thickness for strong magnet hold when Magnet Drilling
9. For drilling holes in steel thicker than 25mm it is recommended to ventilate the hole frequently to clear the swarf
10. For thicker materials, predrill 6.35mm pilot hole first and use then sprung pilot drill or pilot pin as a guide

## QUICK GUIDE

- Optimum life & performance when used with Rotary Pistol Drills
- Good results from SDS Drills when used in Rotary-Only mode
- For best results pre-drill the pilot hole
- Use appropriate lubrication and correct RPM to achieve long tool life

## DOWNLOAD





### Impact Torque

### Revolutions per minute- RPM (Rotary)

Diameter	<12mm Thick Steel		Structural Steel <500 Mpa	Structural Steel <1000 Mpa	Stainless Steel INOX	Brass	Cast Iron (Grey)	Aluminium
	Nm Torque	Ft Lb Torque	32m/Min	18m/Min	12m/Min	32m/Min	16m/Min	45m/Min
<b>Metric</b>	RPM Range							
8MM	200	160	940	540	410	1020	550	1365
10MM	220	175	900	510	380	1005	530	1290
12MM	280	185	875	490	370	995	520	1200
14MM	320	220	690	360	305	700	500	1100
16MM	340	260	640	335	225	660	340	920
18MM	360	270	535	290	210	550	305	800
20MM	380	285	490	230	195	510	250	745
22MM	400	300	460	210	180	470	235	690
24MM	520	385	360	150	140	430	215	490
26MM	545	405	310	140	135	375	200	400
32MM	575	430	290	130	125	340	180	355
<b>Inch</b>	RPM Range							
1/2"	300	205	875	490	370	520	510	1185
9/16"	330	235	690	360	305	450	450	1025
5/8"	335	250	640	335	225	340	340	975
11/16"	350	265	535	290	210	305	305	860
3/4"	370	280	490	230	195	250	280	745
7/8"	425	310	460	210	180	235	235	675
15/16"	460	380	360	150	140	215	215	540
1"	530	390	310	140	135	200	200	410
1-1/16"	575	440	295	130	125	190	385	380

Impact Torque recommendations are the minimum required and for most applications additional torque is a benefit

### BEST PRACTICE ADVICE

GUIDELINE PARAMETERS ONLY - Actual parameters may vary depending on operating conditions

1. Follow guidelines to set correct RPM speed. Incorrect RPM can lead to poor life or tool breakage
2. Apply firm, steady feed pressure throughout the cut, applying the feed very slowly and cautiously during the first 1mm of cut
3. Avoid lateral movement or tilting which can cause damage to the tool
4. Ensure regular application of quality cooling lubricant, especially when drilling thick or hardened materials
5. Hardened or heat-affected materials may require higher torque, reduced RPM and feed rates and extra coolant
6. When drilling into box section ensure the tip of the tool is not contacting the far side of the box section at the same time it is drilling the outside wall. This may cause breakage to the tool
7. Flame cut, laser cut or punched holes may not be possible to ream with Impact Wrench. In this situation ream with a slow speed Magnet Drill with an ImpactaMag or VersaDrive Reamer.

### QUICK GUIDE

- For fastest performance use on Impact Wrenches & Impact Drivers
- Excellent life and performance when used with Rotary Pistol Drills or Pillar Drills
- Suitable for stainless and harder materials if used at low RPM
- Use appropriate lubrication and correct RPM to achieve long tool life

### DOWNLOAD



### BEST PRACTICE ADVICE

GUIDELINE PARAMETERS ONLY - Actual parameters may vary depending on operating conditions

1. Follow guidelines to set correct RPM speed. Incorrect RPM can lead to poor life or tool breakage
2. Apply firm, steady feed pressure throughout the cut, applying the feed very slowly and cautiously during the first 1mm of cut
3. Avoid lateral movement or tilting which can cause damage to the tool
4. Ensure regular application of quality cooling lubricant, especially when drilling thick or hardened materials
5. Hardened or heat-affected materials may require higher torque, reduced RPM and feed rates and extra coolant
6. When drilling into box section ensure the tip of the Step-Drill is not contacting the far side of the box section at the same time it is drilling the outside wall. This may cause breakage to the tool

### QUICK GUIDE

- For fastest performance use on Impact Wrenches & Impact Drivers
- Excellent life and performance when used with Rotary Pistol Drills or Pillar Drills
- Suitable for stainless and harder materials if used at low RPM
- Use appropriate lubrication and correct RPM to achieve long tool life

### DOWNLOAD





Impact Torque

Revolutions per minute- RPM (Rotary)

Diameter	Impact Torque			Impact Torque			Structural Steel <500 Mpa	Structural Steel <1000 Mpa	Stainless Steel INOX	Brass	Cast Iron (Grey)	Plastics	Aluminium
	6mm Thick Steel	12mm Thick Steel	25mm Thick Steel	1/4" Thick Steel	1/2" Thick Steel	1" Thick Steel	32m/Min	18m/Min	12m/Min	32m/Min	16m/Min	30m/Min	45m/Min
	Nm Torque			Ft Lb Torque			RPM Range						
6MM	140	170	280	104	126	207	2040	1070	710	1820	1045	1630	2850
7MM	160	195	300	119	144	222	1780	1020	625	1560	810	1410	2240
8MM	220	270	380	163	200	281	1580	840	550	1340	725	1220	1765
9MM	295	360	520	219	267	385	1210	750	420	1130	600	1040	1550
10MM	320	395	580	237	293	430	1030	520	385	1020	550	990	1480
11MM	325	405	595	241	300	441	980	500	345	960	490	950	1365
12MM	350	430	635	259	319	470	860	440	310	825	405	860	1280
13MM	370	445	675	274	330	500	720	390	260	730	385	745	1160
14MM	375	455	690	278	337	511	660	350	225	665	340	620	950
16MM	455	580	880	337	430	652	535	290	200	610	310	510	875
18MM	580	720	1120	430	533	830	490	245	190	580	275	440	800
20MM	685	845	1245	507	626	922	450	220	175	550	240	350	730
22MM	720	900	1360	533	667	1007	340	180	160	510	210	330	645
3/16"	120	150	220	89	111	163	2270	1135	750	2215	1290	1910	3340
#7	125	155	240	93	115	178	2250	1100	745	2100	1220	1800	3100
7/32"	135	160	260	100	119	193	2125	1095	730	1980	1125	1710	3020
1/4"	150	180	290	111	133	215	1945	1040	680	1715	940	1540	2625
9/32"	175	220	320	130	163	237	1710	985	595	1410	785	1355	2110
5/16"	190	245	350	141	181	259	1695	915	570	1355	760	1290	1940
11/32"	260	330	470	193	244	348	1390	800	515	1435	660	1200	1660
3/8"	300	375	545	222	278	404	1140	665	400	1095	590	1020	1510
27/64"	330	410	610	244	304	452	925	480	330	890	465	915	1320
7/16"	340	420	625	252	311	463	895	455	320	845	430	890	1305
1/2"	365	440	650	270	326	481	780	410	375	780	400	805	1210

Impact Torque recommendations are the minimum required and for most applications additional torque is a benefit

BEST PRACTICE ADVICE

GUIDELINE PARAMETERS ONLY - Actual parameters may vary depending on operating conditions

1. Follow guidelines to set correct RPM speed. Incorrect RPM can lead to poor life or tool breakage
2. Apply firm, steady feed pressure throughout the cut, applying the feed very slowly and cautiously during the first 1mm of cut
3. Avoid lateral movement or tilting which can cause damage to the tool
4. Ensure regular application of quality cooling lubricant, especially when drilling thick or hardened materials
5. Hardened or heat-affected materials may require higher torque, reduced RPM and feed rates and extra coolant
6. VersaDrive TurboTips can be used without piloting at all sizes

QUICK GUIDE

- For fastest performance use on Impact Wrenches & Impact Drivers
- For optimum life and accuracy use with Pistol Drills and Magnet Drills
- Suitable for use on standard construction grade steels such as Structural or Stainless Steel
- Use appropriate lubrication and correct RPM to achieve long tool life

DOWNLOAD



Revolutions per minute- RPM (Rotary)

Diameter	Structural Steel 500Nm	Structural Steel 1000Nm (High Tensile)	Stainless Steel	Special Alloys (Eg Duplex)	Cast Iron	Aluminium / Brass / Plastic
	RPM Range					
4.2mm	2654	1365	1213	682	1820	4625
5mm	2229	1146	1019	573	1529	3885
5.5mm	2027	1042	926	521	1390	3532
6mm	1858	955	849	478	1274	3238
6.5mm	1715	882	784	441	1176	2989
6.8mm	1639	843	749	422	1124	2857
7mm	1592	819	728	409	1092	2775
7.5mm	1486	764	679	382	1019	2590
8mm	1393	717	637	358	955	2428
8.5mm	1311	674	599	337	899	2286
9mm	1238	637	566	318	849	2159
9.5mm	1173	603	536	302	805	2045
10mm	1115	573	510	287	764	1943
10.2mm	1093	562	500	281	749	1905
10.5mm	1062	546	485	273	728	1850
11.5mm	969	498	443	249	665	1689
12mm	929	478	425	239	637	1619
12.5mm	892	459	408	229	611	1554
13mm	857	441	392	220	588	1494
14mm	796	409	364	205	546	1388
16mm	697	358	318	179	478	1214
17.5mm	637	328	291	164	437	1110
18mm	619	318	283	159	425	1079
20mm	557	287	255	143	382	971
21mm	531	273	243	136	364	925
22mm	507	261	232	130	347	883

BEST PRACTICE ADVICE

GUIDELINE PARAMETERS ONLY - Actual parameters may vary depending on operating conditions

1. Follow guidelines to set correct RPM speed. Incorrect RPM can lead to poor life or tool breakage
2. Apply firm, steady feed pressure throughout the cut, applying the feed very slowly and cautiously during the first 1mm of cut
3. Avoid lateral movement or tilting which can cause damage to the tool
4. Ensure regular application of quality cooling lubricant, especially when drilling thick or hardened materials
5. Hardened or heat-affected materials may require higher torque, reduced RPM and feed rates and extra coolant
6. VersaDrive Drill Bits up to 10mm diameter can be driven by an Impact Wrench

QUICK GUIDE

- Optimum life and performance when used with Rotary Pistol Drills
- Up to 10mm can be used on Impact Wrench & Impact Drivers for fast cutting performance
- Suitable for harder materials such as stainless steel when used at reduced RPM
- Use appropriate lubrication and correct RPM to achieve long tool life

DOWNLOAD







### Impact Torque

### Revolutions per minute (Rotary)

Thread Diameter	Impact Tapping Torque			Impact Tapping Torque			Structural Steel	Structural Steel	Stainless Steel	Aluminium	Cast Iron (Grey)	
	6mm Steel	12mm Steel	25mm Steel	1/4" Steel	1/2" Steel	1" Steel	<500 Mpa	<1000 Mpa	INOX			
	Nm Torque			Ft Lbs Torque			RPM Range					
<b>Metric</b>	M3	105	160	N/A	80	120	N/A	960	809	650	2700	1295
	M4	120	180	N/A	90	135	N/A	730	610	490	2060	975
	M5	135	200	N/A	100	150	N/A	585	485	385	1750	780
	M6	140	240	400	105	180	N/A	485	405	325	1455	650
	M8	150	280	430	115	210	330	365	310	245	1095	485
	M10	170	300	480	125	220	360	295	245	195	870	390
	M12	185	320	512	135	235	400	240	200	162	730	330
	M14	190	340	544	140	250	400	210	175	140	625	275
	M16	200	360	576	150	265	425	185	155	125	550	243
	M20	315	400	640	235	300	470	145	125	100	440	194
	M24	N/A	600	960	N/A	440	720	120	100	85	370	165
	M27	N/A	740	1184	N/A	545	875	105	90	75	330	145
	M30	N/A	800	1200	N/A	590	885	95	80	60	310	130
<b>Inch</b>	1/4"	145	255	410	105	180	295	485	405	325	1455	650
	5/16"	145	265	420	110	205	320	365	310	245	1095	485
	3/8"	165	290	440	125	220	355	295	245	195	870	390
	1/2"	190	330	525	135	235	375	240	200	162	730	330
	5/8"	195	355	555	145	265	425	185	155	125	550	243
	3/4"	245	385	615	230	295	470	145	125	100	440	194
	7/8"	N/A	515	775	N/A	370	710	130	115	92	410	180
	1"	N/A	695	1050	N/A	445	735	120	100	85	370	165

Impact Torque recommendations are the minimum required and for most applications additional torque is a benefit

### BEST PRACTICE ADVICE

GUIDELINE PARAMETERS ONLY - Actual parameters may vary depending on operating conditions

1. ImpactaTaps are recommended for through hole applications only
2. Pilot drill the exact tapping size hole for best results
3. Select the correct torque for Impact tools using the table above. If exact match is not available select the closest torque setting above the recommendation
4. Apply firm, steady feed pressure throughout the cut
5. Ensure the Tap is inserted squarely to the hole - poorly aligned or off-centre taps will greatly increase the risk of breakage
6. Regularly apply quality cooling lubricant, especially when drilling thick or hardened materials
7. Hardened or heat-affected materials may require higher torque, reduced RPM and feed rates and extra coolant
8. Flame cut/punched holes will require more torque to tap than drilled holes due to heat build up. Caution: Sometimes flame cut holes do not have parallel sides meaning risk of tap breakage
9. Tap the hole in one pass where possible, applying adequate lubrication before you start.
10. If the tap is over-run from the hole once it is tapped, to remove the risk of cross-threading/damage to the tap, remove the tap from the adapter and locate it in the thread by hand, before reversing
11. When using cordless tools, torque may drop once the battery charge becomes low. Keep batteries well charged. Low battery charge can lead to lower torque which can break or damage taps as point 3
12. When re-threading an existing thread, use caution to avoid cross-threading which can lead to tap breakage or thread damage. It is advisable to insert/start the tap into the thread by hand before driving it through at the correct torque

### QUICK GUIDE

- For fastest performance use on Impact Wrenches & Impact Drivers
- Check the minimum torque requirement
- Laser cut holes & Stainless Steel require higher torque
- Use appropriate lubrication and correct RPM to achieve long tool life

### DOWNLOAD



### Impact Torque

### Revolutions per minute (Rotary)

Thread Diameter	Max Material Thickness	Impact Torque		Structural Steel					Aluminium	Cast Iron (Grey)	
		Nm	Ft Lbs	<500 Mpa	<1000 Mpa	Stainless Steel INOX					
<b>Metric</b>	M3	3mm	105	80	960	810	650	2700	1295		
	M4	4mm	120	90	730	610	490	2060	975		
	M5	5mm	135	100	585	485	385	1750	780		
	M6	6mm	140	105	485	405	325	1455	650		
	M8	8mm	150	115	365	310	245	1095	485		
	M10	10mm	170	125	295	245	195	870	390		
	M12	12mm	185	135	240	200	160	730	330		
<b>Inch (UNC)</b>	4-40	3/32"	105	75	1050	850	710	2900	1390		
	6-32	1/8"	120	90	950	790	650	2700	1295		
	8-32	5/32"	135	95	730	610	490	2060	975		
	10-24	13/64"	135	100	595	475	395	1700	820		
	1/4-20	1/4"	135	105	485	405	325	1455	650		
	5/16-18	5/16"	280	110	365	310	245	1095	485		
	3/8-16	3/8"	300	120	295	245	195	870	390		
	1/2-13	1/2"	320	140	240	200	160	730	330		



Thread Diameter	Impact Torque		Structural Steel					
	Nm	Ft Lbs	<500 Mpa	<1000 Mpa	Stainless Steel INOX	Aluminium	Cast Iron (Grey)	
<b>Metric</b>	M8	280	205	365	310	245	1095	485
	M10	320	220	295	245	195	870	390
	M12	340	235	240	200	160	730	330
	M16	550	425	185	155	125	550	240
	M20	700	475	145	125	100	440	195
	M24	960	630	120	100	85	370	165
<b>Inch (UNC)</b>	1/2-13	340	235	240	200	160	730	330
	5/8-11	550	365	185	155	125	550	240
	3/4-10	700	675	145	125	100	440	195
	1-8	960	735	120	100	85	370	165

Impact Torque recommendations are the minimum required and for most applications additional torque is a benefit

### BEST PRACTICE ADVICE

GUIDELINE PARAMETERS ONLY - Actual parameters may vary depending on operating conditions

1. Impact DrillTaps are recommended for through hole applications only
2. Pilot drill the exact tapping size hole for best results
3. Select the correct torque for Impact tools using the table above. If exact match is not available select the closest torque setting above the recommendation
4. Apply firm, steady feed pressure throughout the cut
5. Ensure the Tap is inserted squarely to the hole - poorly aligned or off-centre taps will greatly increase the risk of breakage
6. Regularly apply quality cooling lubricant, especially when drilling thick or hardened materials
7. Hardened or heat-affected materials may require higher torque, reduced RPM and feed rates and extra coolant
8. Flame cut/punched holes will require more torque to tap than drilled holes due to heat build up. Caution: Sometimes flame cut holes do not have parallel sides meaning risk of tap breakage
9. Tap the hole in one pass where possible, applying adequate lubrication before you start.
10. When tapping material thicker than 15-20mm, to speed up the process it is advisable to pilot drill the hole first, before drill-tapping the hole
11. 301125- Sheet Metal Drill-Taps are intended for tapping material no greater than the tap diameter when driven with an Impact Wrench
12. 301130- Heavy Duty Drill Taps are designed for use with Magnet Drills/Pillar Drills, or for tapping pre-drilled holes with an Impact Wrench. They are not designed for drill-tapping with hand-held rotary tools

### QUICK GUIDE

- For fastest performance use on Impact Wrenches & Impact Drivers
- Check the minimum torque requirement
- Up to M10 (3/8") can also be used on cordless drills
- Ideal for use in Pillar Drills & Magnet Drills
- Correct RPM is critical for good performance on larger sizes
- For Impact Wrench use, pilot drilling is recommended

### DOWNLOAD

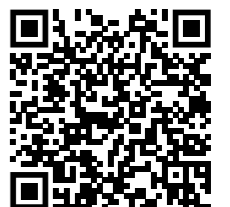



### Impact Torque

### Revolutions per minute (Rotary)

### Revolutions per minute (Rotary)

Diameter	<12mm Thick Steel		<25mm Thick Steel		<1/2" Thick Steel		<1" Thick Steel		Structural Steel <500 Mpa	Structural Steel <1000 Mpa	Stainless Steel INOX	Brass	Cast Iron (Grey)	Aluminium
	Nm Torque		Ft Lb Torque		Ft Lb Torque		Ft Lb Torque		32m/Min	18m/Min	12m/Min	32m/Min	16m/Min	45m/Min
	RPM Range													
<b>8MM</b>	200	380	160	290	160	290	160	290	940	540	410	1020	550	1365
<b>10MM</b>	220	400	175	300	175	300	175	300	900	510	380	1005	530	1290
<b>12MM</b>	280	420	185	305	185	305	185	305	875	490	370	995	520	1200
<b>14MM</b>	320	480	220	330	220	330	220	330	690	360	305	700	500	1100
<b>16MM</b>	340	510	260	390	260	390	260	390	640	335	225	660	340	920
<b>18MM</b>	360	540	270	410	270	410	270	410	535	290	210	550	305	800
<b>20MM</b>	380	570	285	425	285	425	285	425	490	230	195	510	250	745
<b>21MM</b>	390	580	290	430	290	430	290	430	480	225	190	500	240	710
<b>22MM</b>	400	600	300	435	300	435	300	435	460	210	180	470	235	690
<b>24MM</b>	520	780	385	600	385	600	385	600	360	150	140	430	215	490
<b>26MM</b>	650	1000	405	640	405	640	405	640	310	140	135	375	200	400
<b>28MM</b>	720	1080	480	750	480	750	480	750	295	130	125	340	190	360
<b>30MM</b>	780	1365	520	785	520	785	520	785	275	120	110	290	180	330
<b>32MM</b>	940	1410	545	820	545	820	545	820	250	110	100	275	170	305
<b>33MM</b>	970	1440	560	840	560	840	560	840	240	105	95	270	165	295
<b>36MM</b>	1030	1520	600	870	600	870	600	870	215	95	80	255	150	255
<b>39MM</b>	1260	1610	720	920	720	920	720	920	195	80	65	240	135	220
<b>41MM</b>	1340	1736	750	965	750	965	750	965	185	75	60	220	125	200
<b>1/2"</b>	300	445	205	310	205	310	205	310	875	490	370	520	510	1185
<b>9/16"</b>	330	490	235	355	235	355	235	355	690	360	305	450	450	1025
<b>5/8"</b>	335	505	250	375	250	375	250	375	640	335	225	340	340	975
<b>11/16"</b>	350	525	265	400	265	400	265	400	535	290	210	305	305	860
<b>3/4"</b>	370	550	280	420	280	420	280	420	490	230	195	250	280	745
<b>7/8"</b>	425	630	310	440	310	440	310	440	460	210	180	235	235	675
<b>15/16"</b>	460	695	380	575	380	575	380	575	360	150	140	215	215	540
<b>1"</b>	530	805	390	620	390	620	390	620	310	140	135	200	200	410
<b>1-1/16"</b>	575	875	440	660	440	660	440	660	295	130	125	190	385	380

Countersink Diameter	Structural Steel <500 Mpa	Structural Steel <1000 Mpa	Stainless Steel INOX	Aluminium	Cast Iron (Grey)	Plastics
	RPM Range					
<b>12.4 mm</b>	385	255	110	635	265	480
<b>16.5 mm</b>	295	185	80	485	210	345
<b>20.5 mm</b>	230	155	50	385	165	280
<b>25 mm</b>	185	130	50	315	130	225
<b>31 mm</b>	155	105	35	265	105	185

Refer to Page 93 for Pilot Hole Drilling Speeds

### BEST PRACTICE ADVICE

GUIDELINE PARAMETERS ONLY - Actual parameters may vary depending on operating conditions

1. Use with a variable speed motor. Drill and countersink operations should be run at the appropriate speed for each process
2. Apply firm, steady feed pressure throughout the cut
3. Avoid lateral movement or tilting which can cause damage to the tool
4. Ensure regular application of quality cooling lubricant, especially when drilling thick or hardened materials
5. Hardened or heat-affected materials may require higher torque, reduced RPM and feed rates and extra coolant
6. Ensure a debris free surface of sufficient steel thickness for strong magnet hold when Magnet Drilling
7. Use at highest available Gear setting (for maximum torque).
8. Best countersinking results are achieved using a variable speed drill that allows the correct speed to be set
9. Piloted Countersink Bits (like the MultiSink) will significantly increase countersinking performance preventing movement of the countersink whilst drilling
10. Follow guidelines to set correct RPM speed. Incorrect RPM can lead to poor life or tool breakage

### BEST PRACTICE ADVICE

GUIDELINE PARAMETERS ONLY - Actual parameters may vary depending on operating conditions

1. Apply firm, steady feed pressure throughout the cut, applying feed very slowly & cautiously during the first 1mm of cut
2. Avoid lateral movement or tilting which can cause damage to the tool
3. Do not attempt to increase the existing hole diameter beyond 2-3mm. If a larger, finished hole size is required, use the next size reamer to 'step up' until the finished hole diameter is reached.
4. Ensure regular application of quality cooling lubricant, especially when drilling thick or hardened materials
5. Follow guidelines to set correct RPM speed. Incorrect RPM can lead to poor life or tool breakage
6. Flame cut, laser cut or punched holes may not be possible to ream with Impact Wrenches. In this situation ream with a slow speed Magnet Drill
7. Ensure a debris free surface of sufficient steel thickness for strong magnet hold when Magnet Drilling.
8. Regularly check that Magnet Drill slides, handles, arbors and movable parts have not vibrated loose over time.

### QUICK GUIDE

- For fastest performance use on Impact Wrenches & Impact Drivers
- Check the minimum torque requirement
- Reamer should be rotating before starting the cut
- Use steady feed pressure throughout the cut

### DOWNLOAD



### QUICK GUIDE

- Optimum life and performance when used with Rotary Pistol Drills or Pillar Drills
- Up to 16.5mm can be used on Impact Wrench & Impact Drivers for fast cutting performance
- Suitable for harder materials such as stainless steel when used at reduced RPM
- Use appropriate lubrication and correct RPM to achieve long tool life

### DOWNLOAD





Revolutions per minute (Rotary)

Countersink Diameter	Structural Steel <500 Mpa	Structural Steel <1000 Mpa	Stainless Steel INOX	Aluminium	Cast Iron (Grey)	Plastics
6.3 mm (1/4")	765	505	265	1250	500	850
10.4 mm	460	300	145	765	315	530
12.4 mm (1/2")	385	255	110	635	265	480
16.5 mm	295	185	80	485	210	345
20.5 mm (13/16")	230	155	50	385	165	280
25 mm (1")	185	130	50	315	130	225
30 mm	155	105	35	265	105	185
40 mm	120	80	30	205	80	140
55 mm	95	60	25	145	70	120
63 mm	80	55	20	130	55	90
80 mm	65	40	20	100	45	75

## BEST PRACTICE ADVICE

GUIDELINE PARAMETERS ONLY - Actual parameters may vary depending on operating conditions

1. Follow guidelines to set correct RPM speed. Incorrect RPM can lead to poor life or tool breakage
2. Apply firm, steady feed pressure throughout the cut
3. Avoid lateral movement or tilting which can cause damage to the tool
4. Ensure regular application of quality cooling lubricant, especially when drilling thick or hardened materials
5. Hardened or heat-affected materials may require higher torque, reduced RPM and feed rates and extra coolant
6. Ensure a debris free surface of sufficient steel thickness for strong magnet hold when Magnet Drilling
7. Use at highest available Gear setting (for maximum torque)
8. Best countersinking results are achieved using a variable speed drill that allows the correct speed to be set
9. Piloted Countersink Bits (like the MultiSink) will significantly increase countersinking performance preventing movement of the countersink whilst drilling

## QUICK GUIDE

- Optimum life and performance when used with Magnet Drills or Pillar Drills
- Up to 16.5mm can be used on Impact Wrench & Impact Drivers for fast cutting performance
- Suitable for harder materials such as stainless steel when used at reduced RPM
- Use appropriate lubrication and correct RPM to achieve long tool life

## DOWNLOAD



Revolutions per minute (Rotary)

Diameter	Hard Material c. 450 Brinell
16mm	358
18mm	318
20mm	286
22mm	260
24mm	239
26mm	220
28mm	205
30mm	191
32mm	179
34mm	169
36mm	159

Machining of Wear Plates such as HARDOX - CREUSABRO - ABRO - RAEX - STRENX - BISALLOY

## BEST PRACTICE ADVICE

GUIDELINE PARAMETERS ONLY - Actual parameters may vary depending on operating conditions

1. The extreme hardness and resistance of wear plate makes machining it extremely challenging.
2. Good results are dependent on the right setup - including high torque/slow speed, geared Magnet Drills, such as the Versadrive V125T, and correct lubrication
3. Using an incorrect or poorly maintained Magnet Drill with unstable drilling operation, poor magnet hold, excessive pressure or inadequate lubrication is likely to result in rapid tool failure.
4. Even with high tech tooling, successfully machining Wear plates is challenging with little or no margin for error. It not only requires the correct setup but also experienced operators with the time necessary to proceed with caution.
5. Feed should be applied constantly, do not allow the drill to dwell as the material will work harden (if a rest or repositioning of hands is required, then retract the cutting tool slightly off the material first)
6. Constant flood coolant is advisable to carry away any heat generated by cutting, as heat build up can cause work hardening
7. When cutting, any rubbing of the cutting tool must be avoided as it will increase the surface hardness, as wear plate material is designed to 'work-harden' to combat wear and abrasion
8. When using a 2-Geared Speed or 4-Geared Speed drilling machine, the lower gear speeds provide the most torque
9. When using the electronic variable speed and torque controls, maximum torque and power is available when both torque and speed are adjusted to their maximum setting
10. Machines fitted with torque control will try to maintain the selected speed and slow slightly, when under load
11. For best results use the new flood coolant pump with a soluble mix of Biocut Blue lubricant & room temperature tap water.  
Suggested mix: 0.5L of Biocut Blue to 3.5L water



Cordless coolant pump  
See page 65

## DOWNLOAD

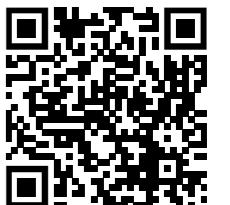



Revolutions per minute (Rotary)

Diameter	Hard Material c. 450 Brinell	
	RPM (No Load) Based on 8.0 m/min	
6mm	424	
8mm	318	
10mm	255	
12mm	212	
14mm	182	
16mm	159	

Machining of Wear Plates such as HARDOX - CREUSABRO - ABRO - RAEX - STRENX - BISALLOY

**BEST PRACTICE ADVICE**

GUIDELINE PARAMETERS ONLY - Actual parameters may vary depending on operating conditions

1. The extreme hardness and resistance of wear plate makes machining it extremely challenging.
2. Good results are dependent on the right setup - including high torque/slow speed, geared Magnet Drills, such as the Versadrive V125T, and correct lubrication
3. Using an incorrect or poorly maintained Magnet Drill with unstable drilling operation, poor magnet hold, excessive pressure or inadequate lubrication is likely to result in rapid tool failure.
4. Even with high tech tooling, successfully machining Wear plates is challenging with little or no margin for error. It not only requires the correct setup but also experienced operators with the time necessary to proceed with caution.
5. Feed should be applied constantly, do not allow the drill to dwell as the material will work harden (if a rest or repositioning of hands is required, then retract the cutting tool slightly off the material first)
6. When drilling hard materials drill required hole size in one operation - do not attempt to pilot drill & step up through drill sizes
7. Constant flood coolant is advisable to carry away any heat generated by cutting, as heat build up can cause work hardening
8. When cutting, any rubbing of the cutting tool must be avoided as it will increase the surface hardness, as wear plate material is designed to 'work-harden' to combat wear and abrasion
9. When using a 2-Geared Speed or 4-Geared Speed drilling machine, the lower gear speeds provide the most torque
10. When using the electronic variable speed and torque controls, maximum torque and power is available when both torque and speed are adjusted to their maximum setting
11. Machines fitted with torque control will try to maintain the selected speed and slow slightly, when under load
12. For best results use the new flood coolant pump with a soluble mix of Biocut Blue lubricant & room temperature tap water.  
Suggested mix: 0.5L of Biocut Blue to 3.5L water



Cordless coolant pump  
See page 65

DOWNLOAD

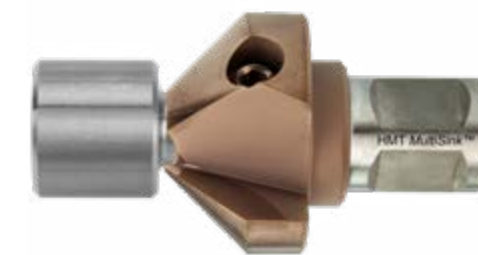

Revolutions per minute (Rotary)

Countersink	Diameter	Hard Material c. 450 Brinell	
		RPM (No Load)	
Ultra Countersink	32mm	80 - 140	
Ultra Multisink	40mm	80 - 140	
Ultra Multisink	55mm	60 - 100	

Machining of Wear Plates such as HARDOX - CREUSABRO - ABRO - RAEX - STRENX - BISALLOY

**BEST PRACTICE ADVICE**

GUIDELINE PARAMETERS ONLY - Actual parameters may vary depending on operating conditions

1. For best results the countersink should be piloted where possible - see Multisink pilots on page 79
2. Do not allow the countersink to vibrate over swarf while cutting as this will cause chatter, ultimately causing the cutting edge to chip & blunt
3. Regular application of lubricant and removal of swarf from the cutting face is essential
4. A hand brush works is helpful to keep excess swarf away from the cut
5. The extreme hardness and resistance of wear plate makes machining it extremely challenging: Gd results are dependent on the right setup - including high torque/slow speed, geared Magnet Drills, such as the Versadrive V125T, and correct lubrication
6. Using an incorrect or poorly maintained Magnet Drill with unstable drilling operation, poor magnet hold, excessive pressure or inadequate lubrication is likely to result in rapid tool failure
7. Even with high tech tooling, successfully machining Wear plates is challenging with little or no margin for error. It not only requires the correct setup but also experienced operators with the time necessary to proceed with caution.
8. Feed should be applied constantly, do not allow the drill to dwell as the material will work harden. (if a rest or repositioning of hands is required, then retract the cutting tool slightly off the material first)
9. Constant coolant is advisable to carry away any heat generated by cutting, as heat build up can cause work hardening. IF a flood cooling system is used for countersinking, consider there will be excess coolant spillage
10. When cutting, any rubbing of the cutting tool must be avoided as it will increase the surface hardness, as wear plate material is designed to 'work-harden' to combat wear and abrasion
11. When using a 2-Geared Speed or 4-Geared Speed drilling machine, the lower gear speeds provide the most torque- When using the electronic variable speed and torque controls, maximum torque and power is available when both torque and speed are adjusted to their maximum setting
12. Machines fitted with torque control will try to maintain the selected speed and slow slightly, when under load



Cordless coolant pump  
See page 65

DOWNLOAD



## TOOLING PRODUCT SUPPORT

HMT offer an industry leading warranty system to provide product users and distributors with peace of mind.

### Product Pledge

One of our core values is 'Optimise' and this means helping users get the best out of their HMT & VersaDrive tooling.

Our products are designed to out-perform any comparable tools in the marketplace. However we live in the real world where no cutting tools are unbreakable and the occasional problem is to be expected.

We utilise tracking software to log and analyse in detail each product issue that is reported. Our statistics show that on average for every 10,000 tools we supply, only 12 tools have to be replaced under warranty, usually under goodwill because the cause of the problem can't be clearly identified as either a defective product or failure caused by user error.

Our Technical staff or sales demonstrators are able to help resolve most product issues either through remote diagnosis or, where possible, a site visit may be appropriate.

### The MATLaS Methodology

We have a solid process to assess any complaint and give fast feedback using our 'MATLaS' methodology to assess reported issues.

<b>Material</b>	Material being cut eg S275, S355 etc
<b>Apparatus</b>	Power tool used, model number & battery
<b>Thickness</b>	5mm, 10mm etc
<b>Lubricant</b>	Was lubricant used & if so which one?
<b>Speed/Torque</b>	What speed/torque setting was used?

Having the information above enables us to identify whether product failure was due to a tooling issue that needs further investigation or an application error that can be addressed to ensure the same issues do not occur in the future.

## ONLINE TECHNICAL SUPPORT

With customers often using products in remote locations, time sensitive jobs or awkward applications, easy access to technical assistance or warranty support can make the difference between successful, on-time project completion or costly delays.

HMT technical support is available online, ensuring access at all times of day or night and wherever a customer might need it via their phone, tablet or computer.

### Online Support Available

- Product Data Sheets - Comprehensive speed & torque guides
- Best Practice Advice
- Power tool recommendations - Guide to choosing the right tool for the job
- Product FAQ sections - Immediately troubleshoot common issues
- Magnetic drill manuals for online viewing and download
- Magnetic drill safety information and user guidance
- Warranty Support forms - typically actioned same day if possible
- Video demonstrations - Youtube & HMT Online

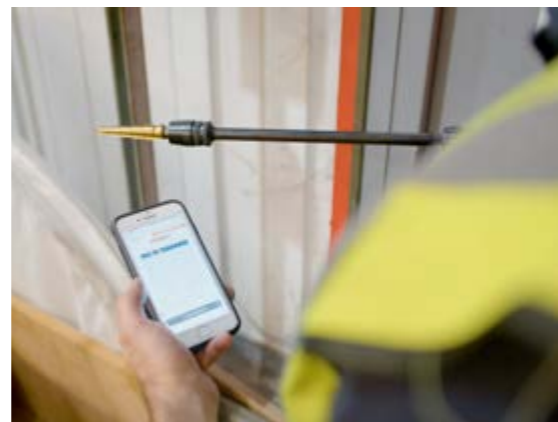

## ONLINE DEALER PORTAL

The HMT Hub is an **online dealer portal**.

Available 24/7, it allows dealers to place orders at any time whilst also providing immediate access to key operational information, activities and advantages such as the below:

- Place orders
- Check pricing & live stock availability
- Track shipments
- View Invoices
- Later next-day delivery cut off time of 4pm (Mainland UK)
- No direct delivery charge  
(direct deliveries ordered outside of the HUB are subject to £5.95 surcharge)
- Access quotes
- View promotions
- Monitor Back Orders
- Access instant acknowledgements
- Download PODs
- & more...



## VersaDrive Magnet Drill REGISTRATION & WARRANTY FORMS

### Magnet Drill REGISTRATION

Register your 2 year VersaDrive Magnet Drill warranty by scanning the QR code below and filling in the online registration form.



### CUTTING TOOL WARRANTY

Should you experience an issue with an HMT cutting tool, please scan the QR code below, complete the form with as much information as possible & one of our technical team will review your case and get back to you.



### Magnet Drill WARRANTY

Should you experience an issue with an HMT Magnet Drill, please scan the QR code below, complete the form with as much information as possible & one of our technical team will review your case and get back to you.





# HOLEMAKER TECHNOLOGY HMT

## HMT Head Office:

Bridge House,  
Pattenden Lane,  
Marden, Kent,  
TN12 9QJ, UK

## HMT Technical Centre:

Europa House,  
Sheffield Business Park,  
Europa Link,  
Sheffield, S9 1XE, UK

**VERSADrive**<sup>®</sup>  
PATENT PROTECTED



[www.holemaker-technology.com](http://www.holemaker-technology.com)  
[sales@holemaker-technology.com](mailto:sales@holemaker-technology.com)

**UK Landline: 03330 110 382**  
**International: +44 1622 522 102**



**JOIN THE REVOLUTION**

We reserve the right to modify without prior notification any details stated in the catalogue regarding product features, versions and designs or any prices quoted. All prices shown are subject to UK VAT where applicable. No liability for printing errors or mistakes shall be assumed. Terms & Conditions apply, copy available on request. Holemaker Technology Ltd, January 2023.